

Products need labeling

## Print and apply systems



**Hermes+**  
Made in Germany



## **cab – Product innovation Made in Germany**

Since more than 40 years cab develops and manufactures solutions and a large amount of accessories for product marking. The product range includes label printers, print and apply systems, label dispensers and marking laser systems. In addition, cab provides ribbons and labels for the perfect imprint.

- 4 - 13** Print and apply systems HERMES+
  - Types
  - Interfaces and connectivity
  - Technical data
- 14 - 15** Applicators
- 16 - 22** Product marking
  - Swing applicator 3214
  - Stroke applicators 4114, 4116
  - Stroke turn applicator 4214
  - Stroke applicator 4414
  - Swing stroke applicator 4514
  - Flag applicator 4712
- 23 - 29** Package marking
  - Front side applicators 3014, 3016
  - Stroke applicators 4014, 4016
  - Stroke blow applicator 4614
  - Demand module 5114
  - Vacuum belt applicators 5314, 5316 and 5414, 5416
  - Air jet box 6014
- 30 - 34** Accessories
  - Special equipment, interfaces, connecting cables
  - Mounting equipment
  - Floor stands
- 35** Printer programming, integration, administration
- 36** Label software
- 37** Printer drivers
- 38 - 41** Delivery program
- 42** Services and trainings



## Print and apply systems HERMES+

Designed for demanding industrial applications

### **HERMES+ represents**

- innovative technology
- reliable and fast printing
- precise labeling
- modular construction
- rugged metal design
- highest quality standards

Hermes+ has been designed for automatic printing and applying in production lines. Applicators allow the labels to be rolled, blown or tamped on a product or packaging.

A wide range of accessories and different floor stands are available to allow flexibility in installation. This facilitates both the integration in already existing and simplifies the project planning of new production lines.

Hermes+ systems turn out to be a safe investment for the future: If requirements should change, such as the product to be marked or the size of the label, the modular design can be individually adapted.





Information is also  
available on the Internet:  
[www.cab.de/en/hermesplus](http://www.cab.de/en/hermesplus)

### Sample applications:

**Marking picking and transport boxes**  
for traceability of the goods



**Marking pharmaceutical products**  
such as test tube carriers  
even when there is only little space  
to stick a label

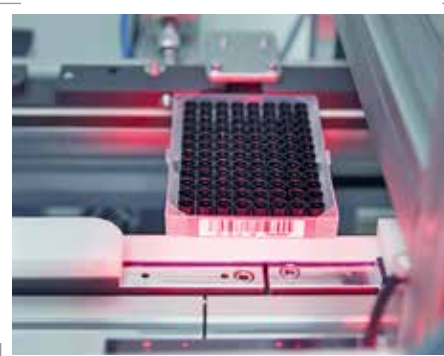

**Marking cardboard or**  
**other product packaging**  
in motion or not in motion





The system is basically split into a print unit and the applicator. Both of them can be combined depending upon individual needs.

As for the print units, two different unwinding diameters and all systems in a left or right hand version are offered as standard.

## Type overview HERMES+

1.1



### Hermes+ 2 - the slim one

for small labels with an accurate imprint

1.1	Label printer		Hermes+ 2	
	Printable resolution	dpi	300	600
	Print speed	up to mm/s	150	100
	Print width	up to mm	54.2	57
	Label roll outside diameter	mm	205 / 305	
	Label width	up to mm	58	

In case of carrier material with a width less than 24 mm the label roll has to be guided by additional margin stops centered to the ribbon to achieve an accurate imprint. Kits are available on request.

1.2



### Hermes+ 4 - the universal one

The best selling industrial device offering an accurate imprint and a wide range of accessories.

1.2	Label printer		Hermes+ 4			Hermes+ 4.3	
	Printable resolution	dpi	203	300	600	203	300
	Print speed	up to mm/s	250	250	100	250	250
	Print width	up to mm	104	105.6	105.6	104	108.4
	Label roll outside diameter	mm	205 / 305				
	Label width	up to mm	114				

1.3



### Hermes+ 6 - the wide one

for Odette, UCC and GS1 labels

1.3	Label printer		Hermes+ 6	
	Printable resolution	dpi	203	300
	Print speed	up to mm/s	200	200
	Print width	up to mm	168	162.6
	Label roll outside diameter	mm	205 / 305	
	Label width	up to mm	174	

# Type overview HERMES+

Hermes+ 2



Label reel diameter 205 mm

Hermes+ 2  
Hermes+ 4  
Hermes+ 6



Label reel diameter 205 mm

Hermes+ 2  
Hermes+ 4  
Hermes+ 6



Label reel diameter 305 mm

Hermes+ L



Dispensing to the left

Hermes+ R



Dispensing to the right

Hermes+ 2 } for label rolls  
Hermes+ 4 } up to 205 mm  
Hermes+ 6 }



Cover protecting from dirt



# Technical details HERMES+

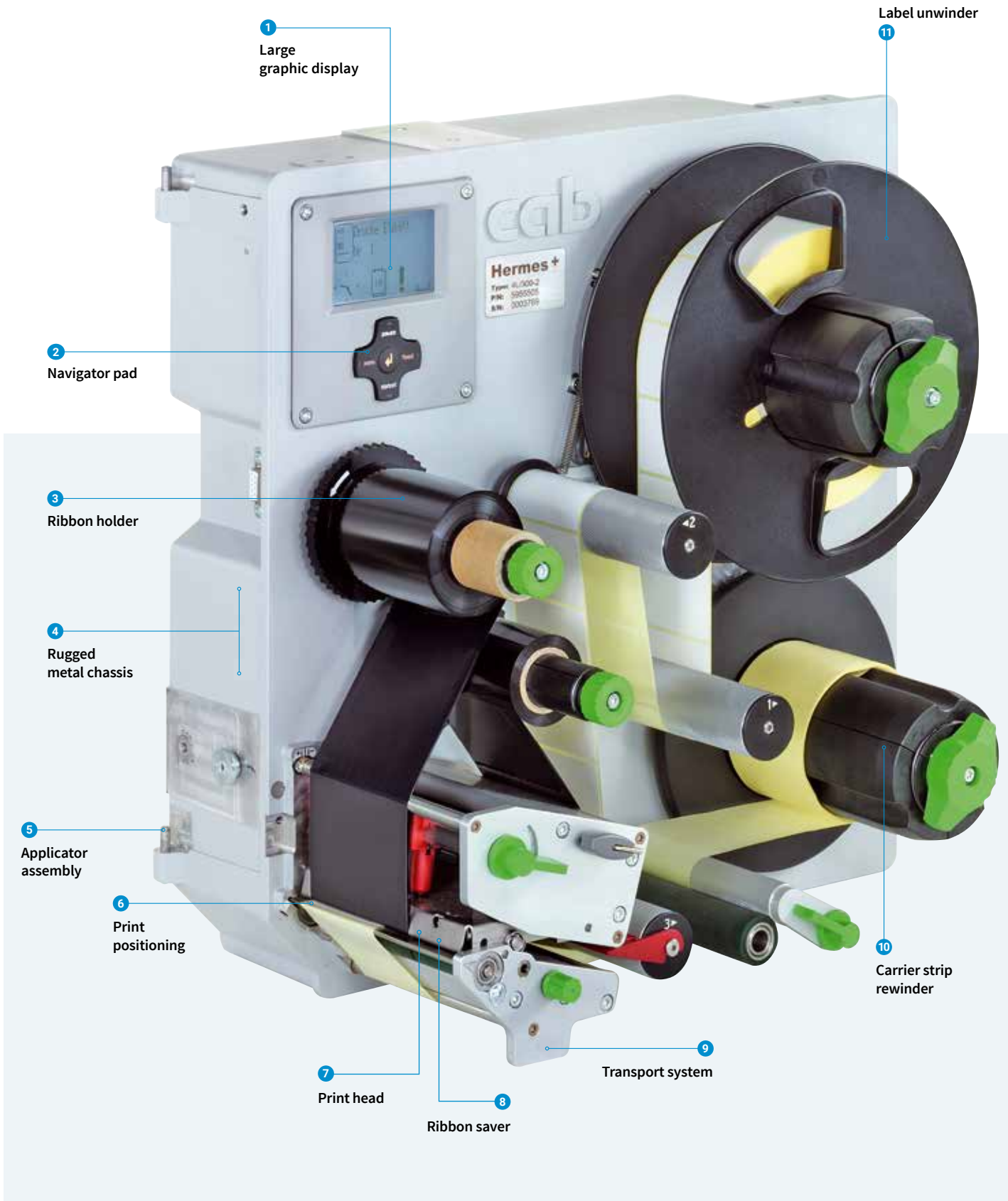



MARIO HISS // SALES DIRECTOR PRINT AND APPLY SYSTEMS

» Every industrial sector has specific requirements on the **quality of the label** and has different **conditions** related to the automation. «



**1 Large graphic display**

White backlight provides optimum readability. Depending on the mounting direction, the display can be rotated in steps of 90°.

**2 Navigator pad**

Simple, interactive menu control; only applicable functions are displayed by the day and night design. Along with the graphic display navigation is easy to understand.

**3 Ribbon holder**

The fast and simple exchange of the ribbon is enabled by three-part tightening axles.

**4 Rugged metal chassis**

made of cast aluminum; basis to assemble all components

**5 Applicator assembly**

Assembled with hinged bolts, the applicator may be easily removed for maintenance.

**6 Print positioning**

The print position is automatically aligned when few labels of a new label roll have been printed. The reference value is kept even when the device is switched off.

**7 Print head**

It can be exchanged in a few quick steps; simple adjustment and setting

**8 Ribbon saver**

This feature is used with partially printed labels. In case of unprinted sectors the print head is lifted and the ribbon is stopped during label feed.

**9 Transport system**

Accurate imprint and precise feeding are enabled by ball bearing feed rolls.

**10 Carrier strip rewinder**

When all labels have been peeled off, the carrier strip of the label roll is fully rewound. The removal of the label roll is simplified by the tightening axle.

**11 Label unwinder**

A swing lever and an integrated brake mechanism make sure that the labels are unwound with constant tension.

**Direction of printing**

All Hermes+ devices with applicators are available in a left and right hand version.

*we identify more*

## Consistent **know-how**, high level **vertical integration**

All mechanical and plastic components used in cab devices and systems are manufactured in-house at the Sömmerda site. Facilities, machinery and equipment are always using the latest technology.

Substantial equipment provides the preconditions to economically manufacture even complex marking systems that set demanding requirements on production processes. The competencies for the whole process chain of electronics, mechanics and software are provided within cab.



For further information see  
<https://we-identify-more.com/en>

# Interfaces HERMES+

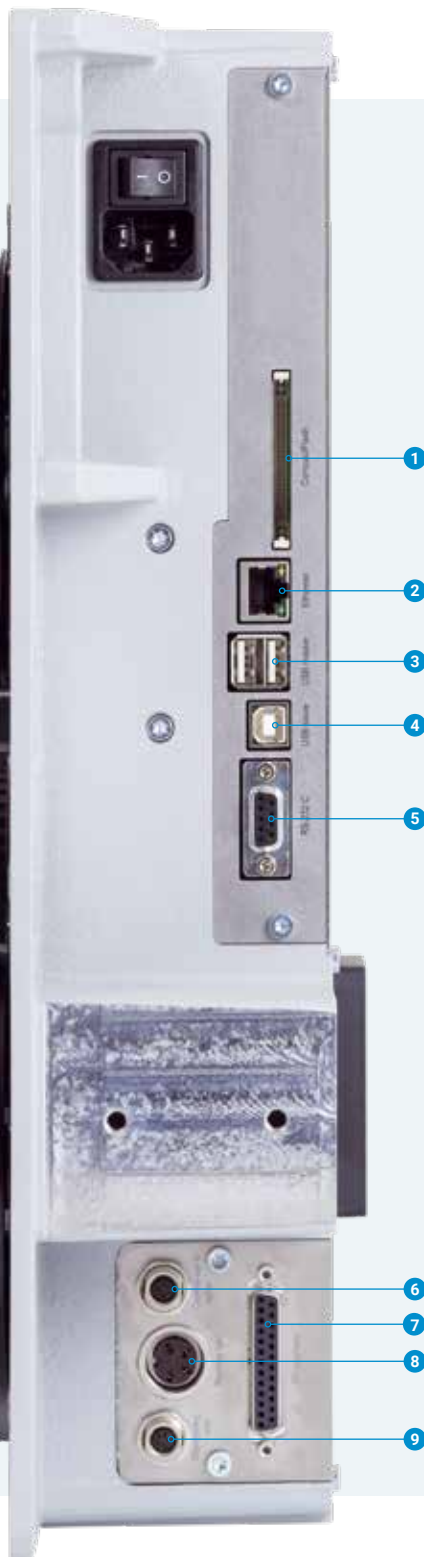

- 1 Slot for **memory card** CompactFlash Type I
- 2 **Ethernet 10/100 BASE-T** interface with TCP/IP
- 3 **2 x USB master** interfaces  
to connect an external operation panel, a keyboard,  
barcode scanner or service key
- 4 **USB 2.0 slave** interface to connect a PC
- 5 **RS232-C** interface
- 6 **Main valve for air pressure supply** connection  
to centrally switch ON/OFF the compressed air supply
- 7 **Digital I/O** interface  
25-pin SUB-D socket connector

Compliant with IEC/EN 61131-2, Type 1+3; all in- and outputs are galvanically isolated and protected from reverse polarity, outputs as well protected from short circuit

#### Inputs PNP

Start printing and applying  
Reprint  
Label feed  
Delete print job  
Pause  
Label dispensed  
Reset  
Stop printing and applying  
Print first label  
Label rotation 90°  
(Applicator 4214)

#### Outputs PNP - NPN on request

Ready  
Print data available  
Paper feed ON  
Pre-warning end of ribbon  
Pre-warning end of label web  
Error end of ribbon  
Error end of label web  
Label in peel-off position  
Initial position / upper end  
Labeling position / lower end  
Common alarm

- 8 **Warning light** connection  
The printer status is displayed:  
**Green** Device switched on  
**Yellow** Pre-warning end of ribbon  
**Red** Error printer or labeler
- 9 **External E-stop** connection  
Along with the plug-in of a main valve this interface allows compressed air supply to be interrupted in case of emergency.

## Options



**Centronics** interface  
bi-directional according to IEEE 1284;  
interface RS422 / RS485 1,200 to 230,400  
baud/8 bit. The interfaces are connected to  
a PC. A USB cable connects with the printer.



**Label selection - I/O box**  
A maximum of 16 different labels are  
selected from a memory card via PLC.  
It is also possible to take control of  
4 in- resp. outputs via Basic Interpreter.



# Technical data

● Typical ○ Possible ■ Standard □ Option

	1.1		1.2				1.3		
	Hermes+ 2		Hermes+ 4.3		Hermes+ 4		Hermes+ 6		
<b>Label printer</b>									
Printing method Thermal transfer	●	●	●	●	●	●	●	●	●
Thermal direct	●	-	●	●	○	○	-	●	●
Printable resolution dpi	300	600	203	300	203	300	600	203	300
Print speed up to mm/s	150	100	250	250	250	250	100	200	200
Print width up to mm	54.2	57	104	108.4	104	105.6	105.6	168	162.6
<b>Labels<sup>1)</sup></b>									
On rolls or reels with Hermes+ 2	Paper, plastics PET, PE, PP, PI, PVC, PU, acrylate								
Thickness / Weight mm / g/m <sup>2</sup>	0.055 - 0.35 / 60 - 160								
Width Labels mm	4 - 58		10 - 114				50 - 174		
Carrier material <sup>2)</sup> roll mm	24 - 62		24 - 118				54 - 178		
reel mm	10 - 62		-				-		
Label height when dispensing mm	4 - 200		8 - 320				25 - 320		
Roll Outside diameter up to mm	205 / 305								
Core diameter roll, standard mm	76		76				76		
roll / adapter, option mm	40 / 50		40 / 50				-		
Winding	outside or inside								
<b>Ribbon<sup>3)</sup></b>									
Ink side	outside or inside								
Roll diameter up to mm	80		80				80		
Core diameter mm	25		25				25		
Variable length up to m	500		500				500		
Width mm	60		114				165		
Ribbon saver	-		□				□		
<b>Internal rewinder</b>									
Outside diameter up to mm	155 / 210								
Core diameter mm	76								
<b>Printer dimensions and weights</b>									
Width mm	207		260				320		
Height with label roll diameter 205 mm mm			400						
305 mm mm			538						
Depth with label roll diameter 205 mm mm			400						
305 mm mm			518						
Weight kg	15		16				20		
<b>Label sensor</b>									
Gap sensor for	Label front edge or punch marks and end of material								
Reflective sensor from below or top for	Print marks								
Distance sensor to locating edge mm	2 - 26		2 - 47				2 - 47		
<b>Electronics</b>									
Processor high-speed 32 bit clock rate MHz	266								
Main storage RAM MB	64								
Data storage MB Flash	8								
Plug-in memory card CompactFlash Type I	■								
Battery for time and date, real-time clock	■								
Error signal	■								
<b>Interfaces</b>									
Centronics bi-directional according to IEEE 1284	□								
RS232-C 1,200 to 230,400 baud/8 bit	■								
USB 2.0 slave to connect a PC	■								
Ethernet 10/100 BASE-T, LPD, RawIP printing, DHCP, HTTP, FTP, SMTP, SNMP, TIME, Zeroconf, SOAP, mDNS	■								
RS422 / RS485 1,200 to 230,400 baud/8 bit	□								
2x USB master to connect an external operation panel, a keyboard, barcode scanner or service key	■								
Warning light	■								
Digital I/O	■								
Applicator	■								
External E-stop	■								
Main valve for air pressure supply	■								
<b>Operating data</b>									
Power supply	100 - 240 VAC, 50/60 Hz, PFC								
Power consumption up to W	300								
Temperature / Humidity Operation	+5 - 40°C / 10 - 85% not condensing								
Storage	0 - 60°C / 20 - 80% not condensing								
Transport	-25 - 60°C / 20 - 80% not condensing								
Approvals	CE, FCC Class A, CB, CCC, UL								

<sup>1)</sup> Limitations may apply to small labels, thin materials or strong adhesives. Critical applications need to be tested.

<sup>2)</sup> In case of carrier material with a width less than 24 mm the label roll has to be guided by additional margin stops centered to the ribbon to achieve an accurate imprint. Kits are available on request.

<sup>3)</sup> The ribbon should at least correspond with the width of the carrier material.

# Technical data

■ Standard □ Option

<b>Operation panel</b>	
Buttons / LED signals	Pause, Feed, Cancel, Menu, Enter, 4 x cursor
LCD graphic display	Width 60 mm, height 40 mm Four lines of text, approx. 20 characters per line
<b>Settings</b>	
	Time, date, analog and digital clock 25 languages System settings, print parameters, interfaces, safety
<b>Display information</b>	
	Data reception                      Clock Ethernet status                      Calendar Used memory                          abc debug Print head temperature              Input buffer Memory card access                  Ribbon remaining
<b>Monitoring</b>	
Print stop in case of	end of ribbon end of label web print head open
Pre-warning to	end of ribbon
<b>Test routines</b>	
System diagnostics when	device is switched on, including print head check
Short status, status printout	Fonts list, type overview, WLAN status, label profile, test grid, monitor mode, PPP status
Status reports	Printout of system settings, for example - print lengths and running times, - system status requests via software command, - display information such as network error, missing link, barcode error, etc.
<b>Fonts</b>	
Font types	5 bitmap fonts including OCR-A, OCR-B and 3 vector fonts Swiss 721, Swiss 721 Bold, Monospace 821 are internally provided, TrueType fonts may be stored
Character sets	Windows 1250 to 1257, DOS 437, 737, 775, 850, 852, 857, 862, 864, 866, 869, EBC DIC 500, ISO 8859-1 to -10 and -13 to -16, WinOEM 720, UTF-8, Macintosh Roman, DEC MCS, K018-R  All West and East European, Latin, Cyrillic, Greek, Hebrew and Arabic characters, Chinese and Thai are supported.
Bitmap fonts	Size in width and height 1 - 3 mm Zoom factor 2 to 10 Orientation 0°, 90°, 180°, 270°
TrueType fonts	Size in width and height 0,9 - 128 mm Variable zoom Orientation 360° in steps of 1°
Font styles	Bold, italic, underlined, outline, inverse - depending on the font type
Character spacing	Variable

<b>Graphics</b>		
Graphic elements	Lines, arrows, rectangles, circles, ellipses - filled and filled with fading	
Graphic formats	PCX, IMG, BMP, TIF, MAC, GIF, PNG	
<b>Barcodes</b>		
Linear	Code 39, Code 93 Code 39 Full ASCII Code 128 A, B, C EAN 8, 13 EAN / UCC 128 EAN / UPC Appendix 2 EAN / UPC Appendix 5 FIM HIBC	Interleaved 2 / 5 Ident and routing code of Deutsche Post Codabar JAN 8, 13 MSI Plessey Postnet RSS 14 UPC A, E, E0
2D and stacked	Aztec Codablock F Data Matrix PDF 417 Micro PDF 417 UPS MaxiCode QR code RSS 14 truncated, limited, stacked and stacked omni-directional EAN/GS1 DataMatrix GS1 DataBar  All codes are variable as regards height, modular width and ratio; orientation 0°, 90°, 180°, 270°  Optionally check digit, plain text printout and start/stop code depending on the type of code	
<b>Software</b>		
Programming	JScript direct programming abc Basic Compiler Database Connector	■ ■ ■
Monitoring / Administration	Printer control Network Manager	■ ■
Label software	cablabel S3 Lite cablabel S3 Viewer cablabel S3 Pro cablabel S3 Print	■ ■ □ □
WHQL certified Windows printer drivers for	Windows Vista Windows 7 Windows 8 Windows 8.1 Windows 10	Server 2008 Server 2008 R2 Server 2012 Server 2012 R2 Server 2016  ■
Apple Mac OS X drivers	from version 10.6	■
Linux printer drivers	from CUPS 1.2	■
Stand-alone operation		■

# Applicators

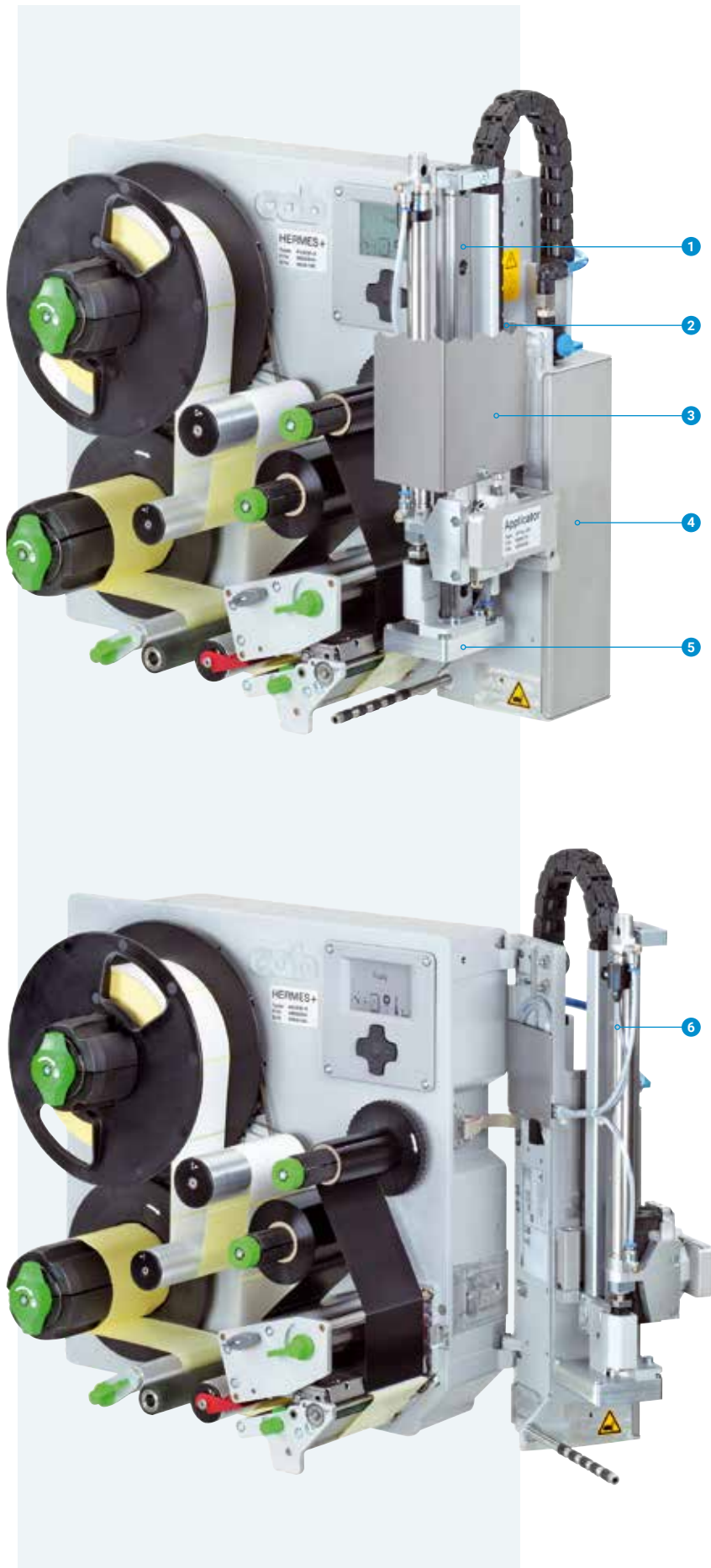

## 1 Long service life

Precise and low-wear linear guidance via a ball bearing chain

## 2 Variable product heights

The stroke applicator enables labeling at different heights. Applicator's lengths are 200, 300 and 400 mm as standard. Further lengths are available on request.

## 3 Protective cover

The cylinder and the guidance are cover-protected as standard. For application at labeling work stations protective covers adapted to the product jig are offered.

## 4 High process reliability

Supporting air, suction air and the stroke speed are all adjustable. Sensor control

## 5 Real-time labeling

Applicators are available for both small and large labels; labels heights 4 - 250 mm and label widths 4 - 174 mm can be processed.

## 6 Pivot applicator

In case of material exchange or maintenance the print mechanics is easily accessible.

## Compressed air regulator

It reduces the contact pressure of the stroke cylinder on the product.



# Overview of applicators and transfer modules

Applicator		Hermes+			Transfer module														Product marking
		2	4	6	Universal pad	Tamp pad	Tamp pad with damping surface	Tamp pad with label stop	Blow pad	Form pad	Universal pad spring-mounted	Tamp pad spring-mounted	Roll-on pad	Corner-wrap pad	Peel-off plate	Vacuum belt	Blow module		
		Order code			11	11	12	61	21	88	31	31	41	51	—	—	90		
5.1	Swing applicator	3214			—	F	F	F	□	—	—	—	—	—	—	—	—		
5.2	Stroke applicator	4114	4116		—	F	F	F	□	□	—	—	—	—	—	—	—		
					—	F	F	F	—	□	—	—	—	—	—	—	—		
5.3	Stroke turn applicator	4214			—	F	F	F	□	—	—	—	—	—	—	—	—		
5.4	Stroke applicator	4414			—	F	F	F	—	—	—	—	—	—	—	—	—		
5.5	Swing stroke applicator	4514			—	—	—	—	□	—	—	—	—	—	—	—	—		
5.6	Flag applicator		4712		—	—	—	—	—	□	—	—	—	—	—	—	—		

5.7	Front side applicators	3014	3016		—	□	—	—	□	—	—	□	—	—	—	—	—
					—	□	—	—	—	—	—	□	—	—	—	—	—
5.8	Stroke applicators	4014	4016		□	F	—	—	□	—	□	□	□	—	—	—	—
					—	□	—	—	—	—	—	□	□	—	—	—	—
5.9	Stroke blow applicator	4614			—	—	—	—	□	—	—	—	—	—	—	—	—
5.10	Demand module	5114			—	—	—	—	—	—	—	—	—	—	□	—	—
5.11	Vacuum belt applicators	5314	5316		—	—	—	—	—	—	—	—	—	—	—	□	—
				5414	5416		—	—	—	—	—	—	—	—	—	—	—
5.12	Air jet box	6014			—	—	—	—	—	—	—	—	—	—	—	—	□

**Applicator type code** 4414L-200

Type	441			
for label printer	Hermes+ 2 Hermes+ 4 Hermes+ 6			
Dispensing	to the left to the right			
Cylinder stroke	200 300 400 500 600 700 800	}	on request	

**F** Enables the tamp pad to immerse in the surface within the label area.

For precise immersion depths see the technical data of the applicators.

# Product marking

## Swing applicator 3214

to precisely apply very small to medium sized labels in real time. The labels are preferably applied from the side on the product.

The pad's position is in front of the peel-off plate. The label is held during the printing. A cylinder rotates to the labeling position. A stroke cylinder applies the label on the product. The angle of rotation and linear stroke are adjustable.

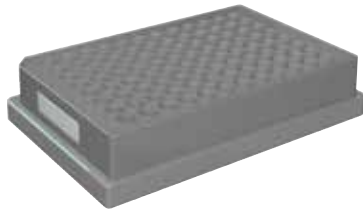

### Tamp pad

Labels are applied on flat, even recessed, surfaces

### Tamp pad with damping surface

to reduce noise when hard surfaces are processed. It is also recommended with rough structures and minor unevenness.

### Tamp pad with label stop

In case small labels are processed, the label stop enables the label to be applied on the product very exactly.

### Blow pad

in case of pressure-sensitive surfaces or when products in motion are processed. Air jet blows the label onto the product.

5- 10 mm distance to the product surface can be adjusted at the stroke cylinder with a stop.

5.1



			Tamp pad	Tamp pad with damping surface	Tamp pad with label stop	Blow pad
Technical data			3214 L/R 11 F	3214 L/R 12 F	3214 L/R 61 F	3214 L/R 2100
Label width	Hermes+ 2	mm	4-58	10-58	10-58	10-58
	Hermes+ 4	mm	10-114	10-114	10-114	10-80
Label height	Hermes+ 2	mm	5-80	8-80	5-80	10-80
	Hermes+ 4	mm	8-80	8-80	8-80	10-80
Product during labeling	not in motion				■	
	in motion		-	-	-	■
Labeling on the product	from the side				■	
Product height	steady				■	
Product distance to peel-off plate	mm			250-280		
Horizontal linear guidance	mm			5-30		
Swing angle				45°-95°		
Pad immersion depth F	up to mm		30	30	30	-
Compressed air	bar			4.5		
Cycle time <sup>1)</sup>	approx. labels/min			20		

<sup>1)</sup> Calculated with label height 40 mm, print speed 100 mm/s

# Product marking

## Stroke applicators 4114, 4116

to precisely apply very small to medium sized labels in real time. The labels can be applied from all sides on the product.

The pad's position is in front of the peel-off plate. The label is held during the printing. A short stroke cylinder horizontally moves the pad to the labeling position. A stroke cylinder applies the label on the product. The length of the stroke cylinder defines the maximum distance between the peel-off plate and the product.



### Tamp pad

Labels are applied on flat, even recessed, surfaces

### Tamp pad with damping surface

to reduce noise when hard surfaces are processed. It is also recommended with rough structures and minor unevenness.

### Tamp pad with label stop

In case small labels are processed, the label stop enables the label to be applied on the product very exactly.

### Blow pad

in case of pressure-sensitive surfaces or when products in motion are processed. Air jet blows the label onto the product.

5- 10 mm distance to the product surface can be adjusted at the stroke cylinder with a stop.

Technical data			Tamp pad	Tamp pad with damping surface	Tamp pad with label stop	Blow pad
Type			4114, 4116 L/R 11 F	4114, 4116 L/R 12 F	4114, 4116 L/R 61 F	4114 L/R 2100
Label width	Hermes+ 2	mm	4-58	10-58	10-58	10-58
	Hermes+ 4	mm	10-114	10-114	10-114	10-114
	Hermes+ 6	mm	50-174	50-174	50-174	-
Label height	Hermes+ 2	mm	4-80	8-80	4-80	10-80
	Hermes+ 4	mm	8-80	8-80	8-80	10-80
	Hermes+ 6	mm	8-80	8-80	8-80	-
Product during labeling	not in motion				■	
	in motion		-	-	-	■
Labeling on the product	from top				■	
	from below				■	
	from the side				■	
Product height	steady		-	-	-	■
	variable		■	■	■	-
Horizontal short stroke cylinder	mm			10		
Product distance to lower edge of device at cylinder stroke 200	up to mm		135	135	135	140
	300	up to mm	235	235	235	240
	400	up to mm	335	335	335	340
Pad immersion depth F <sup>1)</sup>	up to mm		100	100	100	-
Compressed air	bar			4.5		
Cycle time <sup>2)</sup>	approx. labels/min			30		

<sup>1)</sup> With applicator immersion depths higher than 25 mm the cover of Hermes+ has to be modified.

<sup>2)</sup> Calculated with 100 mm stroke below the device, label height 40 mm, print speed 100 mm/s



# Product marking

## Stroke applicators 4114, 4116

to precisely apply very small to medium sized labels in real time. The labels can be applied from all sides on the product.

The pad's position is in front of the peel-off plate. The label is held during the printing. A short stroke cylinder horizontally moves the pad to the labeling position. A stroke cylinder applies the label on the product. The length of the stroke cylinder defines the maximum distance between the peel-off plate and the product.

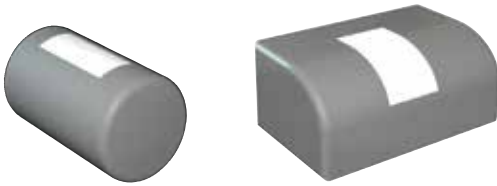

### Form pad

Labels are precisely applied on cylindric, curved or convex surfaces. To avoid blistering on very smooth and flat surfaces, convex form pads are used. In case of cylindric bodies, label wrapping is possible to a maximum of 200°.

Technical data		Type	Form pad
			4114, 4116 L/R 8800
Label width	Hermes+ 2	mm	10 - 58
	Hermes+ 4	mm	10 - 114
	Hermes+ 6	mm	50 - 174
Label height		mm	8 - 80
Product during labeling	not in motion		■
	in motion		-
Labeling on the product	from top		■
	from below		■
	from the side		■
Product height		variable	■
Horizontal short stroke cylinder		mm	10
Product distance to lower edge of device at cylinder stroke	200	up to mm	135
	300	up to mm	235
	400	up to mm	335
Compressed air		bar	4.5
Cycle time <sup>1)</sup>		approx. labels/min	20

<sup>1)</sup> Calculated with 100 mm stroke below the device, label height 40 mm, print speed 100 mm/s  
With form pads higher than 25 mm the cover of Hermes+ has to be modified.

# Product marking

## Stroke turn applicator 4214

to precisely apply very small to medium sized labels when installation is difficult. The labels can be applied from all sides on the product.

The pad's position is in front of the peel-off plate. The label is held during the printing. A cylinder horizontally rotates up to 180° to the labeling position. A stroke cylinder applies the label on the product. The length of the stroke cylinder defines the maximum distance between the peel-off plate and the product.



### Tamp pad

Labels are applied on flat, even recessed, surfaces

### Tamp pad with damping surface

to reduce noise when hard surfaces are processed. It is also recommended with rough structures and minor unevenness.

### Blow pad

in case of pressure-sensitive surfaces or when products in motion are processed. Air jet blows the label onto the product.

### Tamp pad with label stop

In case small labels are processed, the label stop enables the label to be applied on the product very exactly.

5 - 10 mm distance to the product surface can be adjusted at the stroke cylinder with a stop.

Technical data		Type	Tamp pad	Tamp pad with damping surface	Tamp pad with label stop	Blow pad
			4214 L/R 11 F	4214 L/R 12 F	4214 L/R 61 F	4214 L/R 2100
Label width	Hermes+ 2	mm	4 - 58	10 - 58	10 - 58	10 - 58
	Hermes+ 4	mm		10 - 80		
Label height	Hermes+ 2	mm	4 - 40	8 - 40	4 - 40	10 - 40
	Hermes+ 4	mm	8 - 40	8 - 40	8 - 40	10 - 40
Product during labeling	not in motion				■	
	in motion		-	-	-	■
Labeling on the product	from top				■	
	from below				■	
	from the side				■	
Product height	steady		-	-	-	■
	variable		■	■	■	-
Angle of rotation	90°, 0°				■	
Product distance to lower edge of device at cylinder stroke	200	up to mm	135	135	135	140
	300	up to mm	235	235	235	240
	400	up to mm	335	335	335	340
	Pad immersion depth F <sup>1)</sup>	up to mm	65	65	65	-
Compressed air	bar			4.5		
Cycle time <sup>2)</sup>	approx. labels/min			20		

<sup>1)</sup>With applicator immersion depths higher than 25 mm the cover of Hermes+ has to be modified.

<sup>2)</sup>Calculated with 100 mm stroke below the device, label height 40 mm, print speed 100 mm/s

# Product marking

## Stroke applicator 4414

to precisely apply very small to medium sized labels in real time. The final position on the product is adjustable in x and y directions. The labels can be applied from all sides on the product.

The pad's position is in front of the peel-off plate. The label is held during the printing. Two short stroke cylinders horizontally move the pad to the labeling position. A stroke cylinder applies the label on the product. The length of the stroke cylinder defines the maximum distance between the peel-off plate and the product.



5.4



### Tamp pad

Labels are applied on flat, even recessed, surfaces

### Tamp pad with damping surface

to reduce noise when hard surfaces are processed. It is also recommended with rough structures and minor unevenness.

### Tamp pad with label stop

In case small labels are processed, the label stop enables the label to be applied on the product very exactly.

		Tamp pad	Tamp pad with damping surface	Tamp pad with label stop
		4414 L/R 11 F	4414 L/R 12 F	4414 L/R 61 F
<b>Technical data</b>	<b>Type</b>			
Label width	Hermes+ 2	mm	4 - 58	10 - 58
	Hermes+ 4	mm		10 - 114
Label height	Hermes+ 2	mm	4 - 80	4 - 80
	Hermes+ 4	mm		8 - 80
Product during labeling	not in motion		■	
Labeling on the product	from top		■	
	from below		■	
	from the side		■	
Product height	variable		■	
Horizontal short stroke cylinder	x direction mm		3 - 7	
	y direction mm		11 - 15	
Product distance to lower edge of device at cylinder stroke	200	up to mm	135	
	300	up to mm	235	
	400	up to mm	335	
Pad immersion depth F <sup>1)</sup>	up to mm		90	
Compressed air	bar		4.5	
Cycle time <sup>2)</sup>	approx. labels/min		25	

<sup>1)</sup> With applicator immersion depths higher than 25 mm the cover of Hermes+ has to be modified.

<sup>2)</sup> Calculated with 100 mm stroke below the device, label height 40 mm, print speed 100 mm/s

# Product marking

## Swing stroke applicator 4514

to apply labels on the inside surfaces of profiles and pipes in real time. The final position on the product is adjusted at the stroke cylinder with a stop. The labels can be applied from all sides on the product.

The pad's position is in front of the peel-off plate. The label is held during the printing. A cylinder rotates to the labeling level. A stroke cylinder moves the label to the labeling position.



5.5



### Blow pad

With 5 - 10 mm distance to the product surface air jet blows the labels onto the product.

Technical data		Type	Blow pad 4514 L/R 2100
Label width	Hermes+ 2	mm	10-58
	Hermes+ 4	mm	10-80
Label height		mm	10-60
Product during labeling		not in motion	■
Labeling on the product		from top	■
		from below	■
		from the side	■
Product height		steady	■
Vertical angle of rotation			120°
Distance from lower edge of device to top edge of label at cylinder stroke	200	up to mm	150 <sup>2)</sup>
	300	up to mm	250 <sup>2)</sup>
	400	up to mm	350 <sup>2)</sup>
Compressed air		bar	4.5
Cycle time <sup>1)</sup>		approx. labels/min	20

<sup>1)</sup> Calculated with 100 mm stroke below the device, label height 40 mm, print speed 100 mm/s

<sup>2)</sup> depending from the label height



# Product marking

## Flag applicator 4712

to precisely apply labels on round materials such as cables, tubes, pipes, etc. The labels can be applied from all sides on the product.

The pad's position is in front of the peel-off plate. The label is held during the printing. It is moved to the labeling position with a stroke cylinder. Via cam control, the other cylinder places the label around the round material. First of all, it is stuck together at its ends. It is then pressed onto the round material. The length of the stroke cylinder defines the maximum distance between the peel-off plate and the product.

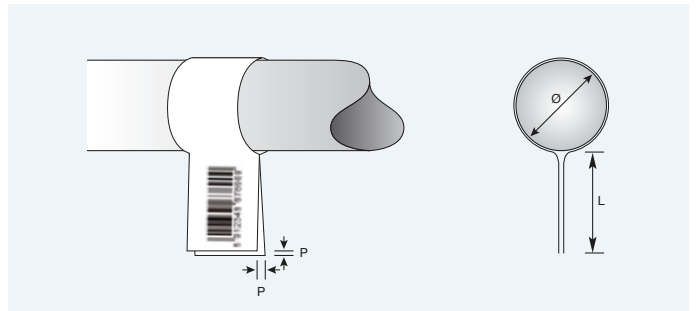
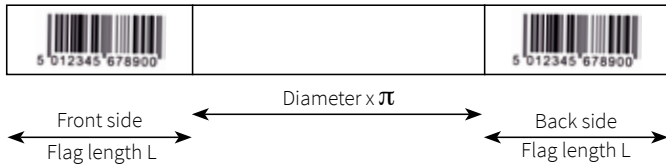
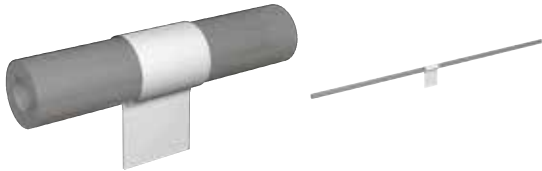

Technical data		Type	Tamp pad
			4712 L 300
Label width Hermes+ 4		mm	60 - 100
Label height		mm	10 - 50
Diameter		mm	3 - 16
Product during labeling	not in motion		■
Labeling on the product	from top		■
	from below		■
	vertically rotated		0 - 180° clockwise; others on request
	from the side		■
Product height	steady		■
Product distance to lower edge of device at cylinder stroke 300	up to mm		260
not less than 70 mm			
Tongs immersion depth	mm		55
Offset P	up to mm		1.0 <sup>2)</sup>
Compressed air	bar		4.5
Cycle time <sup>1)</sup>	approx. labels/min		15

<sup>1)</sup> Calculated with print speed 100 mm/s

<sup>2)</sup> depending from the label quality

# Package marking

## Front side applicators 3014, 3016

to apply labels on packaging in motion in real time.  
The labels are preferably applied on the front or back side.  
Labeling from the top or from the side is possible.  
The pad's position is in front of the peel-off plate.  
The label is taken over during the printing.



The rotary cylinder applies the label on the product.  
A sensor detects the packaging and directs the pivot arm and pad back to its initial position.

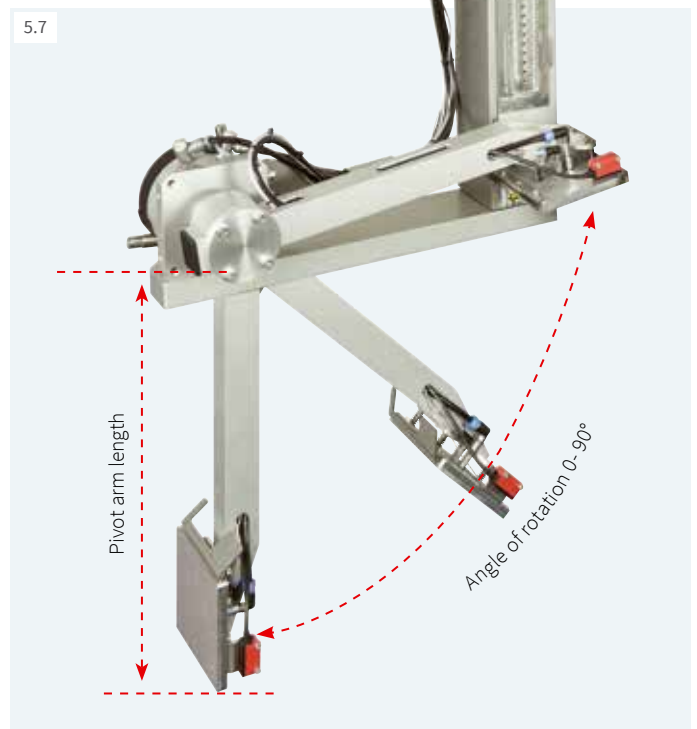

### Tamp pad

Labels are applied on flat, even recessed, surfaces

### Tamp pad spring-mounted

The spring-mounted suction plate enables labeling on inclined surfaces up to 15°. Vertical deviation can be up to 10 mm within the label area.

### Blow pad

With 5- 10 mm distance to the product surface air jet blows the labels onto the product.

Technical data		Type	Tamp pad	Tamp pad spring-mounted	Blow pad
			3014, 3016 L/R 1100	3014, 3016 L/R 3100	3014 L/R 2100
Label width	Hermes+ 4	mm	25 - 114	80 - 114	25 - 114
	Hermes+ 6	mm	25 - 174	80 - 174	-
Label height	Hermes+ 4	mm	8 - 250	80 - 250	10 - 100
	Hermes+ 6	mm	25 - 250	80 - 250	25 - 100
Product during labeling	not in motion		■	■	■
	in motion		■	■	■
Labeling on the product	from top		■	■	■
	from the side		■	■	■
	from the front		■	■	■
	from the back		■	■	■
Product height	variable		■	■	
Pivot arm length <sup>1)</sup>	mm			200 / 300 / 400	
Angle of rotation				0 - 90°	
Compressed air	bar			4.5	
Cycle time <sup>2)</sup>	approx. labels/min			15	

<sup>1)</sup> Pivot arm length defines the accessible 90° labeling position (lower edge of the label) beneath the Hermes+ footprint.

<sup>2)</sup> Calculated with pivot arm length 200 mm, label height 100 mm, print speed 100 mm/s

# Package marking

## Stroke applicators 4014, 4016

to apply labels on packaging or products in real time. Depending from the type of pad, the product is either in motion or not in motion during printing. The labels can be applied from all sides.

The pad's position is in front of the peel-off plate. The label is held during the printing. A stroke cylinder applies the label on the product. A sensor detects the product and directs the pad back to its initial position. The length of the stroke cylinder defines the maximum distance between the peel-off plate and the product.

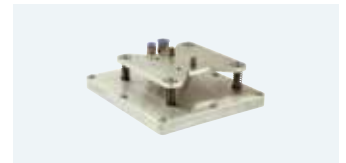

### Tamp pad

Labels are applied on flat, even recessed, surfaces

### Universal pad

Labels are pressed onto flat surfaces. Pre-drilled holes to suck the labels are provided in distances of 5 mm and are covered by a sliding film. They are opened with a punching tool according to the label size. Two films are included in delivery as substitution.

### Tamp pad spring-mounted

Labeling on surfaces with an inclination of up to 15° is enabled by a spring-mounted suction plate. Vertical deviation may be up to 10 mm within the label area.

### Universal pad spring-mounted

Labeling on surfaces with an inclination of up to 15° is enabled by a spring-mounted suction plate. Vertical deviation may be up to 10 mm within the label area. Pre-drilled holes to suck the labels are provided in distances of 5 mm and are covered by a sliding film. Two films are included in delivery as substitution.

			Tamp pad	Universal pad	Tamp pad spring-mounted	Universal pad spring-mounted
			4014, 4016 L/R 11 F	4014 L/R 1100	4014, 4016 L/R 3100	4014 L/R 3100
Label width	Hermes+ 4	mm	20 - 114	75 / 90	80 - 114	116 / 116
	Hermes+ 6	mm	50 - 174	-	80 - 174	-
Label height	Hermes+ 4	mm	20 - 210	60 / 90	80 - 210	102 / 152
	Hermes+ 6	mm	25 - 210	-	80 - 210	-
Product during labeling	not in motion				■	
Labeling on the product	from top				■	
	from below				■	
	from the side				■	
Product height	variable				■	
Product distance to lower edge of device at cylinder stroke 200	up to mm		135	135	130	130
	300	up to mm	235	235	230	230
	400	up to mm	335	335	330	330
Pad immersion depth F <sup>1)</sup>	up to mm	120	-	-	-	-
Compressed air	bar			4.5		
Cycle time <sup>2)</sup>	approx. labels/min			25		

<sup>1)</sup>With applicator immersion depths higher than 25 mm the cover of Hermes+ has to be modified.

<sup>2)</sup> Calculated with 100 mm stroke below the device, label height 100 mm, print speed 100 mm/s

# Package marking

## Stroke applicators 4014, 4016

to apply labels on packaging or products in real time. Depending from the type of pad, the product is either in motion or not in motion during printing. The labels can be applied from all sides.

The pad's position is in front of the peel-off plate. The label is held during the printing. A stroke cylinder applies the label on the product. A sensor detects the product and directs the pad back to its initial position. The length of the stroke cylinder defines the maximum distance between the peel-off plate and the product.

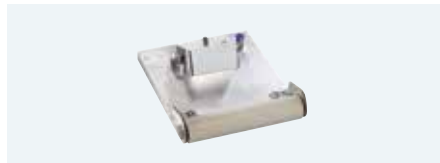

### Blow pad

in case of pressure-sensitive surfaces or when products in motion are processed. Air jet blows the label onto the product.

5- 10 mm distance to the product surface can be adjusted at the stroke cylinder with a stop.

### Roll-on pad

Labels are rolled on flat product surfaces in motion.

### Corner-wrap pad

Labels are applied on two adjacent sides of the product. The tamp pad applies half of the label on the top side of the product, then the second half is rolled on.

Technical data			Blow pad	Roll-on pad	Corner-wrap pad
			4014 L/R 2100	4014, 4016 L/R 4100	4014 L/R 5100
Label width	Hermes+ 4	mm	20 - 114	25 - 114	20 - 114
	Hermes+ 6	mm	-	50 - 174	-
Label height	Hermes+ 4	mm	20 - 100	80 - 250	60 - 210
	Hermes+ 6	mm	-	80 - 250	-
Product during labeling	not in motion		■	-	■
	in motion		■	■	-
Labeling on the product	from top		■	■	-
	from below		■	■	-
	from the side		■	■	-
Product height	steady		■	-	-
	variable		-	■	■
Product distance to lower edge of device at cylinder stroke	200	up to mm	140	160	100
	300	up to mm	240	260	200
	400	up to mm	340	360	300
Compressed air		bar		4.5	
Cycle time <sup>1)</sup>	approx. labels/min		25	20	20

<sup>1)</sup> Calculated with 100 mm stroke below the device, label height 100 mm, print speed 100 mm/s



# Package marking

## Stroke blow applicator 4614

to apply labels on packages of different heights in motion in real time. The labels can be applied from all sides.

The pad's position is in front of the peel-off plate. The label is held during the printing. By means of a sensor, the pad is moved to approximately 10 mm above the product by the stroke cylinder. The length of the stroke cylinder defines the maximum difference in height between the packages.

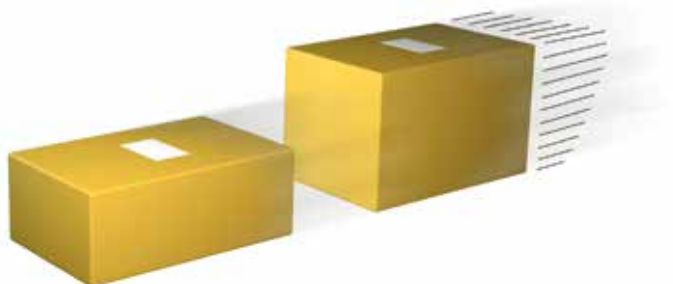

### Blow pad

With 5 - 10 mm distance to the product surface air jet blows the labels onto the product.

Technical data		Type	Blow pad 4614 L/R 2100
Label width	Hermes+ 4	mm	20 - 114
	Hermes+ 6	mm	on request
Label height	Hermes+ 4	mm	20 - 100
	Hermes+ 6	mm	on request
Product during labeling	not in motion		■
	in motion		■
Labeling on the product	from top		■
	from below		■
	from the side		■
Product height	steady		■
	variable		■
Product distance to lower edge of device at cylinder stroke	200	up to mm	140
	300	up to mm	240
	400	up to mm	340
Compressed air		bar	4,5
Cycle time <sup>1)</sup>		approx. labels/min	25

<sup>1)</sup> Calculated with 100 mm stroke below the device, label height 100 mm, print speed 100 mm/s

# Package marking

## Demand module 5114

for serial labeling applications in motion. With the rewind assist roller the label position is adjusted at the dispenser tongue.

The labels can be applied from all sides. Printing and labeling is done simultaneously. The speed of the conveyor belt has to be adapted to the print speed.

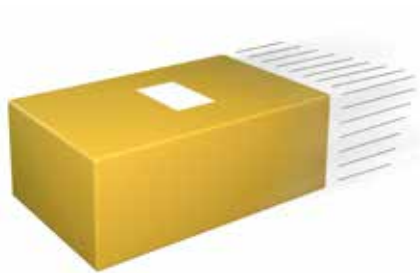

Technical data		Demand module	
		Type	5114 L/R
Label width Hermes+ 4	mm		25 - 114
Label height	mm		25 - 250
Distance from print line to peel-off plate	mm		400 - 600
Product during labeling	in motion		■
Labeling on the product	from top		■
	from below		■
	from the side		■
Product height	steady		■
Product distance to lower edge of device	mm		80
Product speed	mm/s		needs to coincide with the print speed / 50 - 250 in steps of 25
Cycle time <sup>1)</sup>	approx. labels/min		60

<sup>1)</sup> Calculated with label height 100 mm, print speed 100 mm/s

# Package marking

## Vacuum belt applicators 5314, 5316 and 5414, 5416

to apply labels on packaging or products in motion in real time.  
The labels can be applied from all sides on a flat surface, a cylinder resp. corner-wrap.



The position of the vacuum belt applicator is in front of the peel-off plate. The printed label is moved to the labeling position by the vacuum belt and applied on the package with an external signal.

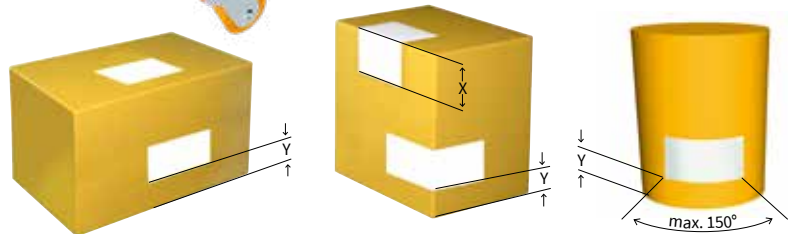

Technical data		Type	Vacuum belt applicator			
			5314-3	5316-3	5414-3	5416-3
Labeling		On the surface		On the surface, a cylinder and corner-wrap		
Dispensing to		left and right				
Label width	Hermes+ 4	mm	20 - 114	-	20 - 114	-
	Hermes+ 6	mm	-	46 - 174	-	46 - 174
Label height		mm	60 - 356	60 - 356	80 - 356	80 - 356
Product during labeling		in motion			■	
Labeling on the product		from top			■	
		from below	■	■	-	-
		from the side			■	
Product height		steady	■			■
		variable		-		■
Product speed		up to m/s	0.5	0.5	0.3	0.3
Gap from one product to the next		not less than m	0.5			
Stability at application level			-	-	F = 30 N	F = 30 N
Corner-wrap labeling		up to mm	-	-	Parameter X = 160	Parameter X = 160
Vacuum belt speed <sup>1)</sup>		mm/s	50 - 500			
Cycle time <sup>2)</sup>		up to labels/min	30	30	15	15
Label distance to conveyor belt when labeling from the side		mm	Parameter Y = 20			

<sup>1)</sup> The product speed has to be higher than the vacuum belt speed. / <sup>2)</sup> Calculated with label height 100 mm, print speed 250 mm/s

# Package marking

## Air jet box 6014

For fast real-time labeling of packaging or products in motion. Preferred method is to apply the labels from top. Labels are sucked with a fan and blown off by nozzels via powerful air jet. Distance from lower edge of the device to the product is, according to the label size, up to 100 mm.

5.12

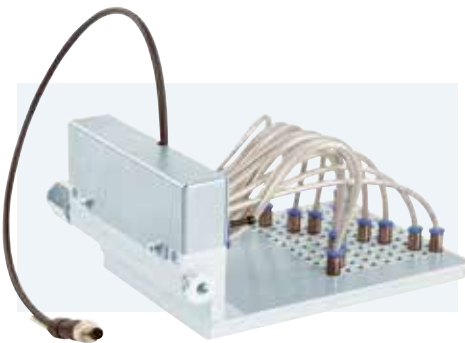

### Blow module

Pre-drilled holes provide suction and blow capabilities. The blow tubes are aligned on the pad based on the label size. The outer area around the label is covered with film. The blow box pad may be easily exchanged for different label sizes.



Technical data		Type	Air jet box
			6014 L/R
Label width	Hermes+ 4	mm	50-114
Label height		mm	50-150
Product during labeling	not in motion		■
	in motion		■
Labeling on the product	from top		■
	from the side		■
Product height	variable		■
Product distance to lower edge		mm	10 - 100
Compressed air		bar	4.5
Cycle time <sup>1)</sup>	approx. labels/min		60

<sup>1)</sup> Calculated with label height 80 mm



# Overview of accessories











■ Standard □ Option

Hermes+ extra equipment		Hermes+ 2	Hermes+ 4	Hermes+ 6
2.1	Cover (only with label rolls up to outside diameter 205 mm)	□	□	□
2.2	External operation panel	□	□	□
2.3	Standard keyboard DE	□	□	□
2.4	Memory card CompactFlash Type I	□	□	□
2.5	Product sensor 25 pin, to connect Hermes+	□	□	□
2.6	Product sensor 3 pin, to connect a front side applicator, vacuum belt applicator, air jet box	-	□	-
2.7	I/O interface connector	□	□	□
2.8	Warning light	□	□	□
2.9	Circular connector 3 pin M8 / 4 pin M8	□	□	□
2.10	Extended peel-off plate +10 mm	□	□	□
2.11	Margin stop	□	□	□
<b>Interfaces</b>				
3.1	Centronics bi-directional according to IEEE 1284	□	□	□
3.2	RS422 / RS485 1,200 to 230,400 baud/8 bit	□	□	□
3.3	Label selection - I/O box	□	□	□
3.4	I/O interface adapter	□	□	□
<b>Connecting cables</b>				
4.1	Connecting cable RS232-C, 9/9 pin, length 3 m	□	□	□
4.2	Patch cable CAT5e, length 3 m, grey	□	□	□





Applicators extra equipment		Type	30	32	40	41	42	44	45	46	60
5.13	Blow tube		□	□	□	□	□	□	□	□	□
5.14	Air pressure regulation unit		□	□	□	□	□	□	□	□	□
5.15	Air pressure regulation unit with main valve		□	□	□	□	□	□	□	□	□
5.16	Air pressure regulation unit with shut-off valve		□	□	□	□	□	□	□	□	□
5.17	Compressed air regulator		-	□	□	□	□	□	-	-	-

Mounting equipment		Hermes+ 2	Hermes+ 4	Hermes+ 6
6.1	Adapter plate	□	□	□
6.2	Profile 40 / 80 / 120 mm - customized length	□	□	□
6.3	Base plate 500 x 255 mm	□	□	-
6.4	Mounting plate	□	□	□
6.5	Bracket	□	□	□
6.6	Clamped joint for profile 50 x 50 mm	□	□	□
6.7	Flanged joint for profile 50 x 50 mm	□	□	□
6.8	Floor stand 1601	□	□	□
6.9	Floor stand 1602	□	□	□
<b>Software</b>				
7.1	JScript direct programming	■	■	■
7.2	Replace files and integration in SAP R/3	■	■	■
7.3	abc Basic Compiler	■	■	■
7.4	Printer control in Intranet und Internet	■	■	■
7.5	Database Connector	■	■	■
7.6	Label software cablabel S3 Lite	■	■	■
	Label software cablabel S3 Pro	□	□	□
	Label software cablabel S3 Print	□	□	□
7.7	Network Manager	■	■	■
7.8	Printer drivers Windows	■	■	■
7.9	Printer drivers Apple Mac OS X, Linux	■	■	■
7.10	Programming manual	■	■	■



# Extra equipment, interfaces, connecting cables

Extra equipment Hermes+	
2.1	 <p><b>Cover</b> to protect from dirt and accidental contact. With applicator immersion depths higher than 25 mm the cover has to be modified; approved for vertical installation</p>
2.2	 <p><b>External operation panel</b> If the operation panel is not accessible after printer installation, an external one can be additionally connected. A slot to plug-in a CompactFlash Type 1 memory card and a USB host interface are also in place.</p>
2.3	 <p><b>Standard keyboard DE</b> USB connection, 115 keys</p>
2.4	 <p><b>Memory card CompactFlash Type I</b> to store label formats, fonts, text and graphics; readable and writable in the printer or at a PC</p>
2.5	 <p><b>Product sensor 25 pin</b> to connect Hermes+; if a product has been detected, for example on a conveyor belt, labeling is started</p>
2.6	 <p><b>Product sensor 3 pin</b> to connect a front side applicator, vacuum belt applicator, air jet box; if a product has been detected, for example on a conveyor belt, labeling is started</p>
2.7	 <p><b>I/O interface connector</b> with screw terminals to connect all control signals at the Hermes+ I/O interface</p>
2.8	 <p><b>Warning light</b> In addition to the display, the warning light indicates the printer status:</p> <p><b>Red</b> Error printer or labeler <b>Yellow</b> Pre-warning end of ribbon <b>Green</b> Device switched on</p> <p>It is mounted directly at the printer, the bracket or anywhere else within the working area; connecting cable: length 1 m</p>
2.9	 <p><b>Circular connector</b> 3 pin M8 / 4 pin M8</p>
2.10	 <p><b>Extended peel-off plate +10 mm</b> for labels that are hard to remove; available on request</p>
2.11	 <p><b>Margin stop</b> to guide material if narrow labels are processed</p>





  

Interfaces	
3.1	 <p><b>Centronics</b> bi-directional according to IEEE 1284</p>
3.2	 <p><b>RS422 / RS485</b> 1,200 to 230,400 baud/8 bit</p>
3.3	 <p><b>Label selection - I/O box</b> Via a master control, for example PLC, up to 16 different labels can be selected from the memory card.</p>
3.4	 <p><b>I/O interface adapter</b> to adapt the 15 pin connector of a Hermes A system to the 25 pin connector of Hermes+</p>

Connecting cables	
4.1	 <p><b>Connecting cable RS232-C</b> 9/9 pin, length 3 m</p>
4.2	 <p><b>Patch cable CAT5e</b> Length 3 m, grey</p>

  

Extra equipment applicators	
5.13	 <p><b>Blow tube</b></p>
5.14	 <p><b>Air pressure regulation unit</b> to be mounted directly at Hermes+ or the bracket; default setting 4.5 bar</p>
5.15	 <p><b>Air pressure regulation unit with main valve</b> If the apply system is integrated in a unit, compressed air needed by the applicator can be externally switched on and off; default setting 4.5 bar only if combined with an E-stop</p>
5.16	 <p><b>Air pressure regulation unit with shut-off valve</b> for fully venting the hose lines next to the air pressure regulation unit when the air jet box 6014 is in use</p>
5.17	<p><b>Compressed air regulator</b> to reduce the tamp force of stroke applicators</p>

## Mounting equipment

### Mounting foot

to assemble a Hermes+ on a table or within a production line. It is available in a left and right hand version. If needed, the size of the mounting foot can be tailored to the application.

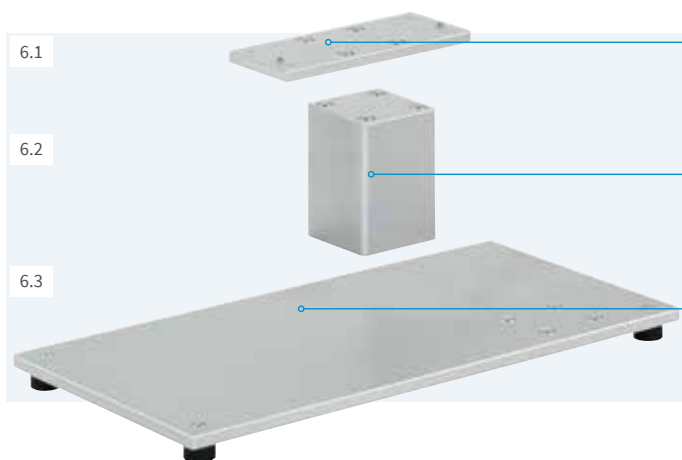

#### 1 Adapter plate

The apply system can be fixed on the adapter plate. It may also be mounted with the adapter plate and the profile directly in the production line.

#### 2 Profile

Aluminum square profile, standard lengths 40, 80, 120 mm; customized lengths are possible on request

#### 3 Base plate

to fix the printer holder; standard length 500 x 255 mm

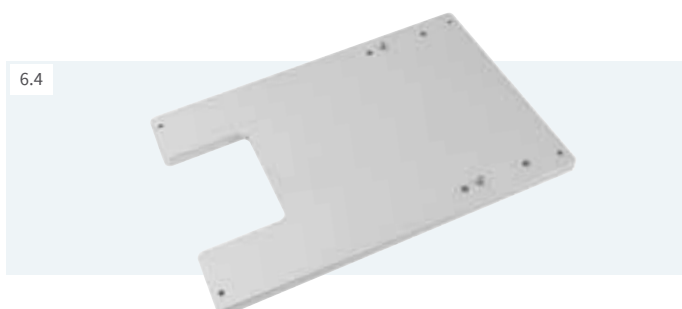

#### Mounting plate

to fix the label printer directly in the production line

## Mounting equipment

6.5



### Bracket

to assemble Hermes+ at the floor stand

6.6

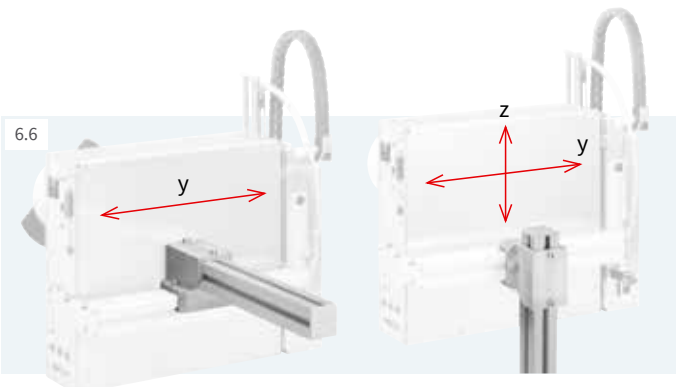

### Clamped joint for profile 50 x 50 mm

to move the apply system in horizontal and vertical direction

6.7

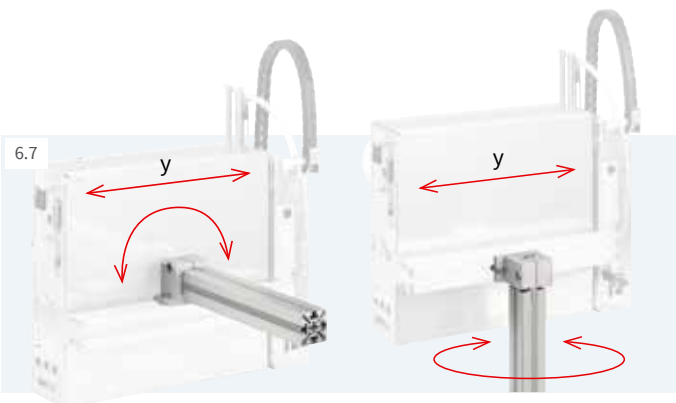

### Flanged joint for profile 50 x 50 mm

to move the apply system in horizontal direction and rotate it around one axis

# Floor stands

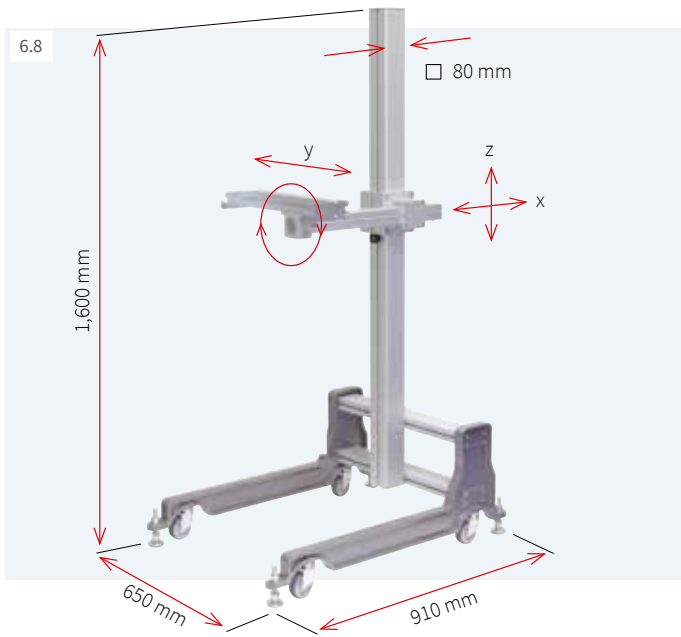

Floor stands help with installing all Hermes+ print and apply systems in a production line. By means of the adjustability the Hermes+ can be arranged in three axes to the product that has to be labeled. Rotation is also possible.

### Floor stand 1601

Preferred use is with applications in different production lines. The floor stand is moveable and can be aligned with adjustable feet at the place of application.

		Floor stand
		1601
Technical data	Type	
Base frame		Guide rollers and adjustable feet
Adjustment of height and depth		Screw terminals
Load in case of offset 500 mm	up to kg	50
Weight	kg	36

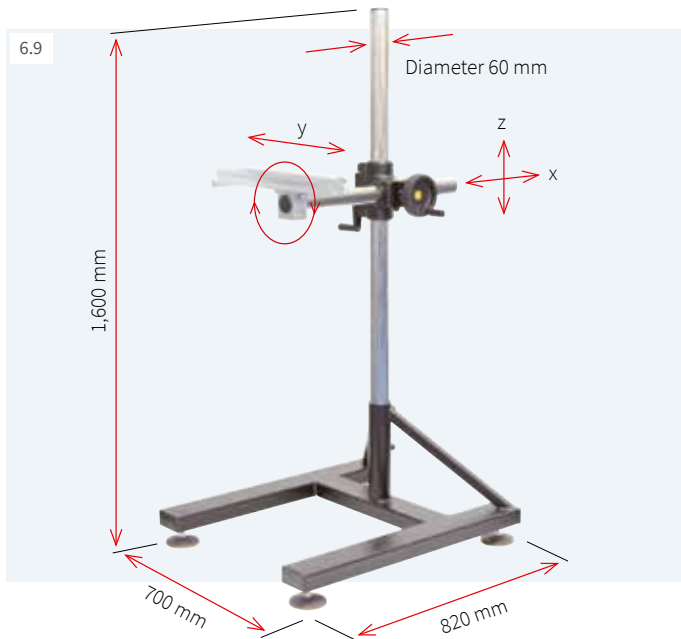

### Floor stand 1602

Preferred use is with applications in which the heights and depths of the labeling position have to be changed frequently. By means of the toothed rack construction Hermes+ can be arranged in x and z direction to the product.

		Floor stand
		1602
Technical data	Type	
Base frame		Adjustable feet
Adjustment of height of depth		Toothed rack / Crank Toothed rack / Handwheel
Load in case of offset 500 mm	up to kg	50
Weight	kg	38

## Samples for printer assembly

### Labeling in direction of transport

from top

from the side



### Labeling crosswise direction of transport

from top

from the side

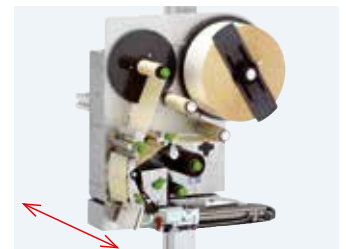



# Label software cablabel S3



The intuitive **cablabel S3** user interface provides different date formats, mathematical or logic functions.

- 1 Toolbar**  
to create different label objects
- 2 Tabs**  
to quickly switch from one running label design to another
- 3 Layers**  
to manage different label objects
- 4 Designer**  
Label display in WYSIWYG mode to simplify the design
- 5 Printer spooler**  
to monitor all print jobs and printer status
- 6 Drivers**  
to manage settings and the communication with devices

## Designing, printing, monitoring with cablabel S3

cablabel S3 opens up the full potential of cab devices.

First of all the label must be designed. Only when it comes to printing it has to be decided whether the label shall be processed on a label printer, a print and apply or marking laser system.

cablabel S3 is of a modular design which makes it adaptable to requirements step by step. To support functions like native JScript programming elements such as the JScript Viewer are embedded as plug-ins. The designer user interface and the JScript code are synchronized in real time. Special functions like the Database Connector or barcode testers can be integrated.

For further information see [www.cab.de/en/cablabel](http://www.cab.de/en/cablabel)

## Printing in stand-alone operation

This operating mode is the printer's ability to select and print labels even when it is not connected to a host system.

The label has to be designed with a software such as cablabel S3 or by direct programming with a text editor on a PC. Label formats, texts, graphics as well as database contents are saved or read on a memory card, a USB memory stick or in the internal IFFS storage.

Only variable data are sent to the printer via a keyboard, barcode scanner, weighing or other host systems. With the Database Connector, these data are recalled from the host and printed.

# Printer drivers

To control the printer with a software other than cablabel S3, cab provides drivers in 32 / 64 bit for operating systems starting from Windows Vista, Mac OS X 10.6 and Linux with CUPS 1.2.

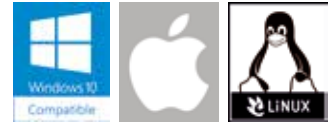

### Windows<sup>1)</sup> drivers

cab printer drivers are certified according to WHQL. They ensure optimum stability on the Windows operating system.

### Mac OS X<sup>2)</sup> drivers

cab provides CUPS-based printer drivers for Mac OS X applications.

### Linux drivers

Linux drivers are CUPS-based

Drivers are offered on the DVD delivered with the printer and for free download at [www.cab.de/en/support](http://www.cab.de/en/support)

# Printer programming

J	Job Start
H 100	Speed (100 mm / s)
O R	Orientation rotated by 180°
S l1;0,0,68,70,100	Size of label (100x68 mm, gap 2 mm)
T 10, 10,0,5,pt20;sample	Text object/font: Swiss bold, 20 pt
B 10,20,0,EAN-13,SC2,401234512345	Barcode EAN 13; size SC 2
G 8,3,5,0;R:30,9,0,3;0,3	Graphic, box 30 x 9 mm, Line weight 0,3 mm
A 1	Number of labels (in this example 1)



### JScript

To control the printer cab has developed the embedded programming language JScript. See manual for free download at [www.cab.de/en/programming](http://www.cab.de/en/programming)

### ABC abc Basic Compiler

In addition to JScript and as an integral part of the firmware it allows advanced printer programming before data are sent to printout. For example, external printer languages can be replaced without interfering in the current print job.

Also data from other systems such as a scale, a barcode scanner or PLC can be integrated.

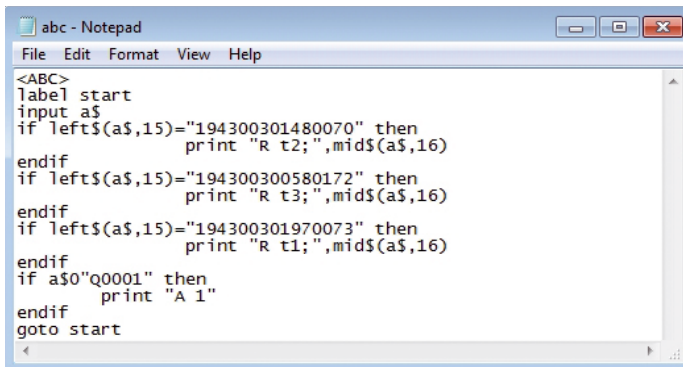

<sup>1)</sup> Windows is a registered trademark of Microsoft Corporation <sup>2)</sup> MAC OS X is a registered trademark of Apple Computer, Inc.

## Printer integration

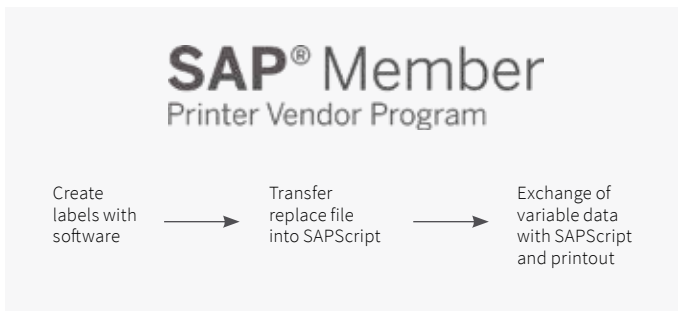

### Printer Vendor Program

As a partner in SAP's<sup>1)</sup> Printer Vendor Program cab has developed a replace method to enable easy control of a cab printer via SAPScript from SAP R/3. Only variable data is sent to the printer by the host. Pictures and fonts that priorly had been stored in the local memory (IFFS, memory card, etc.) are merged.



### Database Connector

Printers connected to a network may directly access data from a central ODBC- or OLEDB-ready database and print it on a label. While printing, data can be rewritten to the database.

## Printer administration

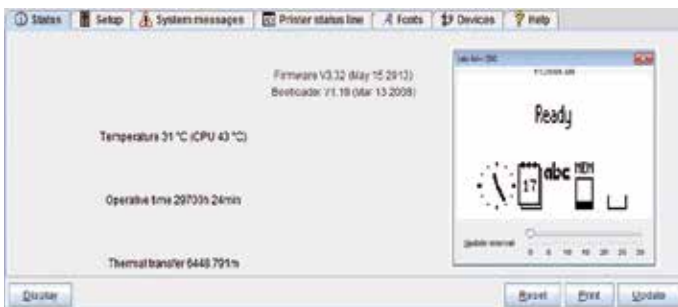

### Configuration in Intranet and Internet

The HTTP and FTP server integrated in the printer via standard programs like a web browser or FTP clients allows printer control and configuration, firmware updates and memory card administration. Via email or SNMP, the SNMP and SMTP client datagram sends status, warning and error messages to administrators and users. Time and date are synchronized by a time server.

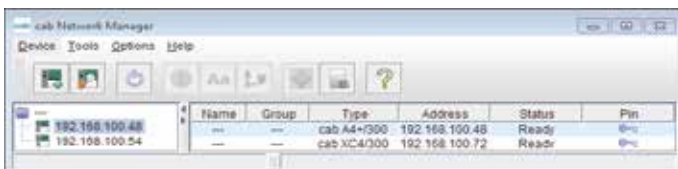





### Network Manager

It is possible to simultaneously manage several printers within the network. Control, configuration, firmware updates, memory card administration, data synchronization and PIN administration are supported from one single location.

<sup>1)</sup> SAP and all corresponding logos are trademarks or registered trademarks of SAP SE.

# Delivery program printers

Pos.	Part no.	Devices L	Part no.	Wear parts	Part no.	Wear parts	Part no.	Wear parts
	1.1	<b>5955502</b> Label printer Hermes+ 2L/300-2	<b>5954105.001</b>	Print head 2/300	<b>5954102.001</b>	Print roller DR2	<b>5961015.001</b>	Drawing roller ZR2
		<b>5955503</b> Label printer Hermes+ 2L/600-2	<b>5958686.001</b>	Print head 2/600				
	1.2	<b>5955504</b> Label printer Hermes+ 4L/200-2	<b>5954081.001</b>	Print head 4/203	<b>5954180.001</b>	Print roller DR4	<b>5961298.001</b>	Drawing roller ZR4
		<b>5955505</b> Label printer Hermes+ 4L/300-2	<b>5954072.001</b>	Print head 4/300				
		<b>5955506</b> Label printer Hermes+ 4L/600-2	<b>5954077.001</b>	Print head 4/600				
		<b>5955507</b> Label printer Hermes+ 4.3L/200-2	<b>5954085.001</b>	Print head 4.3/203				
	<b>5955508</b> Label printer Hermes+ 4.3L/300-2	<b>5954089.001</b>	Print head 4.3/300					
1.3	<b>5955509</b> Label printer Hermes+ 6L/200-2	<b>5954217.001</b>	Print head 6/203	<b>5954245.001</b>	Print roller DR6	<b>5961220.001</b>	Drawing roller ZR6	
	<b>5955510</b> Label printer Hermes+ 6L/300-2	<b>5956322.001</b>	Print head 6/300					
	1.1	<b>5961410</b> Label printer Hermes+ 2L/300-3	<b>5954105.001</b>	Print head 2/300	<b>5954102.001</b>	Print roller DR2	<b>5961015.001</b>	Drawing roller ZR2
		<b>5961411</b> Label printer Hermes+ 2L/600-3	<b>5958686.001</b>	Print head 2/600				
	1.2	<b>5955511</b> Label printer Hermes+ 4L/200-3	<b>5954081.001</b>	Print head 4/203	<b>5954180.001</b>	Print roller DR4	<b>5961298.001</b>	Drawing roller ZR4
		<b>5955512</b> Label printer Hermes+ 4L/300-3	<b>5954072.001</b>	Print head 4/300				
		<b>5955513</b> Label printer Hermes+ 4L/600-3	<b>5954077.001</b>	Print head 4/600				
		<b>5955514</b> Label printer Hermes+ 4.3L/200-3	<b>5954085.001</b>	Print head 4.3/203				
		<b>5955515</b> Label printer Hermes+ 4.3L/300-3	<b>5954089.001</b>	Print head 4.3/300				
	1.3	<b>5955516</b> Label printer Hermes+ 6L/200-3	<b>5954217.001</b>	Print head 6/203	<b>5954245.001</b>	Print roller DR6	<b>5961220.001</b>	Drawing roller ZR6
		<b>5955517</b> Label printer Hermes+ 6L/300-3	<b>5956322.001</b>	Print head 6/300				
	Pos.	Part no.	Devices R	Part no.	Wear parts	Part no.	Wear parts	Part no.
	1.1	<b>5955752</b> Label printer Hermes+ 2R/300-2	<b>5954105.001</b>	Print head 2/300	<b>5954102.001</b>	Print roller DR2	<b>5961015.001</b>	Drawing roller ZR2
		<b>5955753</b> Label printer Hermes+ 2R/600-2	<b>5958686.001</b>	Print head 2/600				
	1.2	<b>5955754</b> Label printer Hermes+ 4R/200-2	<b>5954081.001</b>	Print head 4/203	<b>5954180.001</b>	Print roller DR4	<b>5961298.001</b>	Drawing roller ZR4
		<b>5955755</b> Label printer Hermes+ 4R/300-2	<b>5954072.001</b>	Print head 4/300				
		<b>5955756</b> Label printer Hermes+ 4R/600-2	<b>5954077.001</b>	Print head 4/600				
		<b>5955757</b> Label printer Hermes+ 4.3R/200-2	<b>5954085.001</b>	Print head 4.3/203				
	<b>5955758</b> Label printer Hermes+ 4.3R/300-2	<b>5954089.001</b>	Print head 4.3/300					
1.3	<b>5955759</b> Label printer Hermes+ 6R/200-2	<b>5954217.001</b>	Print head 6/203	<b>5954245.001</b>	Print roller DR6	<b>5961220.001</b>	Drawing roller ZR6	
	<b>5955760</b> Label printer Hermes+ 6R/300-2	<b>5956322.001</b>	Print head 6/300					
	1.1	<b>5961412</b> Label printer Hermes+ 2R/300-3	<b>5954105.001</b>	Print head 2/300	<b>5954102.001</b>	Print roller DR2	<b>5961015.001</b>	Drawing roller ZR2
		<b>5961413</b> Label printer Hermes+ 2R/600-3	<b>5958686.001</b>	Print head 2/600				
	1.2	<b>5955761</b> Label printer Hermes+ 4R/200-3	<b>5954081.001</b>	Print head 4/203	<b>5954180.001</b>	Print roller DR4	<b>5961298.001</b>	Drawing roller ZR4
		<b>5955762</b> Label printer Hermes+ 4R/300-3	<b>5954072.001</b>	Print head 4/300				
		<b>5955763</b> Label printer Hermes+ 4R/600-3	<b>5954077.001</b>	Print head 4/600				
		<b>5955764</b> Label printer Hermes+ 4.3R/200-3	<b>5954085.001</b>	Print head 4.3/203				
		<b>5955765</b> Label printer Hermes+ 4.3R/300-3	<b>5954089.001</b>	Print head 4.3/300				
	1.3	<b>5955766</b> Label printer Hermes+ 6R/200-3	<b>5954217.001</b>	Print head 6/203	<b>5954245.001</b>	Print roller DR6	<b>5961220.001</b>	Drawing roller ZR6
		<b>5955767</b> Label printer Hermes+ 6R/300-3	<b>5956322.001</b>	Print head 6/300				

Pos.	Part no.	Device options
	<b>595xxxx.201</b>	Label printer Hermes+ with cover <sup>1)</sup>
	<b>595xxxx.202</b>	Label printer Hermes+ with ribbon saver <sup>2)</sup>
	<b>595xxxx.203</b>	Label printer Hermes+ with cover <sup>1)</sup> and ribbon saver <sup>2)</sup>
	<b>On request</b>	Roll core diameter 40 mm only with label printers Hermes+ 2 and Hermes+ 4
	<b>5961406</b>	Adapter for core diameter 50 mm
		„x“ - choose device from Pos. 1.1-1.3

Scope of delivery	
	Label printer Power cable Type E+F, length 1,8 m Connecting cable USB, length 1,8 m Operator's manual DE / EN
<b>DVD:</b>	Operator's manual DE / EN / FR Configuration manual DE / EN / FR Service manual DE / EN Spare parts list DE / EN Programming manual EN WHQL certified Windows printer drivers for Windows Vista Server 2008 Windows 7 Server 2008 R2 Windows 8 Server 2012 Windows 8.1 Server 2012 R2 Windows 10 Server 2016 Label software cablabel S3 Lite Label software cablabel S3 Viewer













Type code		
Label printer Hermes+		<b>4L/200-2</b>
Label width	58 mm	<b>2</b>
	114 mm	<b>4</b>
	174 mm	<b>6</b>
Dispensing to	left	<b>L</b>
	right	<b>R</b>
Printable resolution	203 dpi	<b>200</b>
	300 dpi	<b>300</b>
	600 dpi	<b>600</b>
for label roll outside diameter up to 205 mm		<b>2</b>
for label roll outside diameter up to 305 mm		<b>3</b>

<sup>1)</sup> Maximum label roll outside diameter 205 mm

<sup>2)</sup> Only with Hermes+ 4 and Hermes+ 6

With tamp pad immersion depths higher than 25 mm, the cover of Hermes+ has to be modified.











# Delivery program applicators and transfer modules

Pos.		Part no.	Applicators L		Part no.	Transfer modules
5.1		<b>5970075</b>	Swing applicator 3214L-40		XXXXXXX XXXXXXX XXXXXXX XXXXXXX	Tamp pad Tamp pad with damping surface Tamp pad with label stop Blow pad 3214L-11 F W x H 3214L-12 F W x H 3214L-61 F W x H 3214L-2100 W x H
5.2		<b>5966109</b> <b>5966110</b> <b>5966111</b>	Stroke applicator Stroke applicator Stroke applicator 4114L-200 4114L-300 4114L-400		XXXXXXX XXXXXXX XXXXXXX XXXXXXX XXXXXXX	Tamp pad Tamp pad with damping surface Tamp pad with label stop Blow pad Form pad 4114L-11 F W x H 4114L-12 F W x H 4114L-61 F W x H 4114L-2100 W x H 4114L-8800 W x H
		<b>5971795</b> <b>5972016</b> <b>5972017</b>	Stroke applicator Stroke applicator Stroke applicator 4116L-200 4116L-300 4116L-400		XXXXXXX XXXXXXX XXXXXXX XXXXXXX	Tamp pad Tamp pad with damping surface Tamp pad with label stop Form pad 4116L-11 F W x H 4116L-12 F W x H 4116L-61 F W x H 4116L-8800 W x H
5.3		<b>5966117</b> <b>5966118</b> <b>5966119</b>	Stroke turn applicator Stroke turn applicator Stroke turn applicator 4214L-200 4214L-300 4214L-400		XXXXXXX XXXXXXX XXXXXXX XXXXXXX	Tamp pad Tamp pad with damping surface Tamp pad with label stop Blow pad 4214L-11 F W x H 4214L-12 F W x H 4214L-61 F W x H 4214L-2100 W x H
5.4		<b>5966133</b> <b>5966134</b> <b>5966135</b>	Stroke applicator Stroke applicator Stroke applicator 4414L-200 4414L-300 4414L-400		XXXXXXX XXXXXXX XXXXXXX	Tamp pad Tamp pad with damping surface Tamp pad with label stop 4414L-11 F W x H 4414L-12 F W x H 4414L-61 F W x H
5.5		<b>5971625</b> <b>5966168</b> <b>5971640</b>	Swing stroke applicator Swing stroke applicator Swing stroke applicator 4514L-200 4514L-300 4514L-400		XXXXXXX	Blow pad 4514L-2100 W x H
5.6		<b>5971815</b>	Flag applicator 4712L-300			
5.7		<b>5970100</b> <b>5970101</b> <b>5970102</b>	Front side applicator Front side applicator Front side applicator 3014L-200 3014L-300 3014L-400		XXXXXXX XXXXXXX XXXXXXX	Tamp pad Tamp pad spring-mounted Blow pad 3014L-1100 W x H 3014L-3100 W x H 3014L-2100 W x H
		<b>5970103</b> <b>5970104</b> <b>5970105</b>	Front side applicator Front side applicator Front side applicator 3016L-200 3016L-300 3016L-400		XXXXXXX XXXXXXX	Tamp pad Tamp pad spring-mounted 3016L-1100 W x H 3016L-3100 W x H
5.8		<b>5966101</b> <b>5966102</b> <b>5966103</b>	Stroke applicator Stroke applicator Stroke applicator 4014L-200 4014L-300 4014L-400		<b>5966147</b> <b>5966148</b> <b>5966149</b> <b>5966150</b>	Universal pad Universal pad Universal pad spring-mounted Universal pad spring-mounted 4014L-1100 75 x 60 4014L-1100 90 x 90 4014L-3100 116 x 102 4014L-3100 116 x 152
					XXXXXXX XXXXXXX XXXXXXX XXXXXXX XXXXXXX	Tamp pad Blow pad Tamp pad spring-mounted Roll-on pad Corner-wrap pad 4014L-11 F W x H 4014L-2100 W x H 4014L-3100 W x H 4014L-4100 W x H 4014L-5100 W x H / H
		<b>5966161</b> <b>5966162</b> <b>5966163</b>	Stroke applicator Stroke applicator Stroke applicator 4016L-200 4016L-300 4016L-400		XXXXXXX XXXXXXX XXXXXXX	Tamp pad Tamp pad spring-mounted Roll-on pad 4016L-11 F W x H 4016L-3100 W x H 4016L-4100 W x H
5.9		<b>5971720</b> <b>5971725</b> <b>5971730</b>	Stroke blow applicator Stroke blow applicator Stroke blow applicator 4614L-200 4614L-300 4614L-400		XXXXXXX	Blow pad 4614L-2100 W x H
5.10		<b>5966144</b>	Demand module 5114L			
5.11		<b>5972730</b> <b>5972750</b>	Vacuum belt applicator Vacuum belt applicator 5314L-3 5316L-3			
		<b>5972940</b> <b>5972920</b>	Vacuum belt applicator Vacuum belt applicator 5414L-3 5416L-3			
5.12		<b>5971582</b>	Air jet box 6014L		<b>5971581</b> XXXXXXX	Blow module Blow module 6014 L/R universal 6014L W x H configured

XXXXXXX - user specific part no. following request























# Delivery program applicators and transfer modules

Pos.		Part no.	Applicators R		Part no.	Transfer modules
5.1		<b>5971655</b>	Swing applicator 3214R-40		XXXXXXX XXXXXXX XXXXXXX XXXXXXX	Tamp pad Tamp pad with damping surface Tamp pad with label stop Blow pad 3214R-11 F W x H 3214R-12 F W x H 3214R-61 F W x H 3214R-2100 W x H
5.2		<b>5966113</b> <b>5966114</b> <b>5966115</b>	Stroke applicator Stroke applicator Stroke applicator 4114R-200 4114R-300 4114R-400		XXXXXXX XXXXXXX XXXXXXX XXXXXXX XXXXXXX	Tamp pad Tamp pad with damping surface Tamp pad with label stop Blow pad Form pad 4114R-11 F W x H 4114R-12 F W x H 4114R-61 F W x H 4114R-2100 W x H 4114R-8800 W x H
		<b>5972018</b> <b>5972019</b> <b>5972020</b>	Stroke applicator Stroke applicator Stroke applicator 4116R-200 4116R-300 4116R-400		XXXXXXX XXXXXXX XXXXXXX XXXXXXX	Tamp pad Tamp pad with damping surface Tamp pad with label stop Form pad 4116R-11 F W x H 4116R-12 F W x H 4116R-61 F W x H 4116R-8800 W x H
5.3		<b>5966121</b> <b>5966122</b> <b>5966123</b>	Stroke turn applicator Stroke turn applicator Stroke turn applicator 4214R-200 4214R-300 4214R-400		XXXXXXX XXXXXXX XXXXXXX XXXXXXX	Tamp pad Tamp pad with damping surface Tamp pad with label stop Blow pad 4214R-11 F W x H 4214R-12 F W x H 4214R-61 F W x H 4214R-2100 W x H
5.4		<b>5966137</b> <b>5966138</b> <b>5966139</b>	Stroke applicator Stroke applicator Stroke applicator 4414R-200 4414R-300 4414R-400		XXXXXXX XXXXXXX XXXXXXX	Tamp pad Tamp pad with damping surface Tamp pad with label stop 4414R-11 F W x H 4414R-12 F W x H 4414R-61 F W x H
5.5		<b>5966950</b> <b>5971460</b> <b>5971700</b>	Swing stroke applicator Swing stroke applicator Swing stroke applicator 4514R-200 4514R-300 4514R-400		XXXXXXX	Blow pad 4514R-2100 W x H
5.7		<b>5970106</b> <b>5970107</b> <b>5970108</b>	Front side applicator Front side applicator Front side applicator 3014R-200 3014R-300 3014R-400		XXXXXXX XXXXXXX XXXXXXX	Tamp pad Tamp pad spring-mounted Blow pad 3014R-1100 W x H 3014R-3100 W x H 3014R-2100 W x H
		<b>5970109</b> <b>5970110</b> <b>5970111</b>	Front side applicator Front side applicator Front side applicator 3016R-200 3016R-300 3016R-400		XXXXXXX XXXXXXX	Tamp pad Tamp pad spring-mounted 3016R-1100 W x H 3016R-3100 W x H
5.8		<b>5966105</b> <b>5966106</b> <b>5966107</b>	Stroke applicator Stroke applicator Stroke applicator 4014R-200 4014R-300 4014R-400		<b>5966140</b> <b>5966141</b> <b>5966142</b> <b>5966143</b>	Universal pad Universal pad Universal pad spring-mounted Universal pad spring-mounted 4014R-1100 75 x 60 4014R-1100 90 x 90 4014R-3100 116 x 102 4014R-3100 116 x 152
		<b>5966165</b> <b>5966166</b> <b>5966167</b>	Stroke applicator Stroke applicator Stroke applicator 4016R-200 4016R-300 4016R-400		XXXXXXX XXXXXXX XXXXXXX XXXXXXX	Tamp pad Blow pad Tamp pad spring-mounted Roll-on pad Corner-wrap pad 4014R-11 F W x H 4014R-2100 W x H 4014R-3100 W x H 4014R-4100 W x H 4014R-5100 W x H / H
5.9		<b>5971735</b> <b>5971740</b> <b>5971745</b>	Stroke blow applicator Stroke blow applicator Stroke blow applicator 4614R-200 4614R-300 4614R-400		XXXXXXX	Blow pad 4614R-2100 W x H
		<b>5966145</b>	Demand module 5114R			
5.11		<b>5972740</b> <b>5972760</b>	Vacuum belt applicator Vacuum belt applicator 5314R-3 5316R-3			
		<b>5972950</b> <b>5972930</b>	Vacuum belt applicator Vacuum belt applicator 5414R-3 5416R-3			
5.12		<b>5971577</b>	Air jet box 6014R		<b>5971581</b> XXXXXXX	Blow module Blow module 6014 L/R universal 6014R W x H configured

XXXXXXX - user specific part no. following request

# Delivery program accessories

Pos.		Part no.	Hermes+ extra equipment
2.1		<b>5961000.001</b> <b>5961070.001</b> <b>5961193.001</b>	Cover 2L Cover 4L Cover 6L
		<b>5961190.001</b> <b>5961187.001</b> <b>5961196.001</b>	Cover 2R Cover 4R Cover 6R
			With tamp pad immersion depths higher than 25 mm, the cover of Hermes+ has to be modified.
2.2		<b>5954380</b>	External operation panel
2.3		<b>5901626</b>	Standard keyboard DE
2.4		<b>5561043</b>	Memory card CompactFlash Type I
2.5		<b>5964300</b>	Product sensor 25 pin
2.6		<b>5970071</b>	Product sensor 3 pin
2.7		<b>5917651</b>	I/O interface connector SUB-D, 25 pin
2.8		<b>5961237.001</b>	Warning light
2.9		<b>5918092</b> <b>5918003</b>	Circular connector 3 pin M8 Circular connector 4 pin M8
2.10		<b>5961625</b> <b>5961624</b> <b>5961658</b>	Extended peel-off plate Hermes+ 2 Extended peel-off plate Hermes+ 4 Extended peel-off plate Hermes+ 6
2.11		<b>5961650</b>	Margin stop
Pos.		Part no.	Interfaces
3.1		<b>5954200</b>	Centronics
3.2		<b>5954201</b>	RS422 / RS485
3.3		<b>5948205</b>	Label selection - I/O-Box
3.4		<b>5961349</b>	I/O interface adapter
Pos.		Part no.	Connecting cables
4.1		<b>5550818</b>	Connecting cable RS232-C 9/9 pin, length 3 m
4.2		<b>5918008</b>	Patch cable CAT 5e, length 3 m, grau
Pos.		Part no.	Applicators extra equipment
5.13		<b>5964277.001</b> <b>5964095.001</b> <b>5964614.001</b>	Blow tube 2" Blow tube 4" Blow tube 6"
5.14		<b>5955735</b>	Air pressure regulation unit L
		<b>5955736</b>	Air pressure regulation unit R

Pos.		Part no.	Applicators extra equipment		
5.15		<b>5955737</b>	Air pressure regulation unit L with additional main valve		
		<b>5955738</b>	Air pressure regulation unit R with additional main valve		
5.16		<b>5971556</b>	Air pressure regulation unit L with shut-off valve		
		<b>5971559</b>	Air pressure regulation unit R with shut-off valve		
5.17		<b>596xxx.212</b>	Compressed air regulator		
Pos.		Part no.	Mounting equipment		
6.1		<b>5965940</b>	Adapter plate		
6.2		on request	Profile (customized length)		
6.3		<b>5961203</b>	Base plate 500 x 255 mm		
6.4		<b>5958400</b>	Mounting plate		
6.5		<b>5955685</b>	Bracket		
6.6		<b>8914443</b>	Clamped joint for profile 50 x 50 mm		
6.7		<b>8914444</b>	Flanged joint for profile 50 x 50 mm		
6.8		<b>5970113</b>	Floor stand 1601		
6.9		<b>5970112</b>	Floor stand 1602		
Pos.		Part no.	Software		
7.6		<b>5588000</b>	Label software cablabel S3 Lite		
		<b>5588001</b> <b>5588100</b> <b>5588101</b> <b>5588150</b> <b>5588151</b> <b>5588152</b>	cablabel S3 Pro 1 WS cablabel S3 Pro 5 WS cablabel S3 Pro 10 WS cablabel S3 Pro 1 additional licence cablabel S3 Pro 4 additional licences cablabel S3 Pro 9 additional licences		
		<b>5588002</b> <b>5588105</b> <b>5588106</b> <b>5588155</b> <b>5588156</b> <b>5588157</b>	cablabel S3 Print 1 WS cablabel S3 Print 5 WS cablabel S3 Print 10 WS cablabel S3 Print 1 additional licence cablabel S3 Print 4 additional licences cablabel S3 Print 9 additional licences		
		In preparation	cablabel S3 Print Server		
		<b>9008486</b>	Programming manual EN, printed copy		
		7.10		<b>9008486</b>	Programming manual EN, printed copy

## Services

Well-trained cab service engineers worldwide support in the maintenance and repair of the devices.

Send your printer to a cab service center or a cab service partner selected by us. Your device will be checked and repaired within few workdays. If requested, a loan device will be offered.

You prefer maintenance and repair on-site in your company? Then make an appointment with our Services Department:

Phone **+49 721 6626 300**, Email: [service.de@cab.de](mailto:service.de@cab.de)

## Trainings

Enhance your know-how on cab devices with regard to an effective use, service and repair.

In Karlsruhe we offer trainings on the handling of the devices, label design, software, printer drivers, programming, database access as well as on how to integrate in networks or superior ERP systems. We gladly send you detailed information on all our current training offers on request.

Individually we offer trainings according to your specific demands - in Karlsruhe or on-site in your company.



# cab Product overview

**Label printers MACH1, MACH2**  
in the lower price segment



**Label printers MACH 4S**  
where little space is available



**Label printers EOS1**  
Desktop device for label rolls up to diameter 152 mm



**Label printers EOS4**  
Desktop device for label rolls up to diameter 203 mm



**Label printers SQUIX 2**  
Industrial device for print widths up to 57 mm



**Label printers SQUIX 4**  
Industrial device for print widths up to 108 mm



**Label printers SQUIX 6**  
Industrial device for print widths up to 168 mm



**Label printers A8+**  
Industrial device for print widths up to 216 mm



**Label printers XD4T**  
for double-sided printing



**Label printers XC**  
for two-color printing



**Print and apply systems Hermes+**  
for automation



**Print and apply systems Hermes C**  
for two-color printing and applying



**Print modules PX**  
to be integrated in labeling machines



**Labels**  
made from more than 400 materials



**Ribbons**  
in wax, resin and resin/wax qualities



**Label software cablabel S3**  
Design, print, control



**Label dispensers HS, VS**  
for horizontal or vertical dispense



**Labeling heads IXOR**  
to be integrated in labeling machines



**Marking lasers FL+**  
with output powers 10 to 50 Watt



**Laser marking systems XENO 1**  
for single workpieces and series

