



PX Series Print Module

Made in Germany

PX print modules

Our goals are:

Perfect function, high reliability, easy to handle operation and less maintenance downtime.

The PX print module is designed especially for the fully automatic print and apply operation in the industrial use. It can be integrated in each orientation and used for complex labeling applications.



A solid cast aluminum design is base for the assembly of all components of the printing mechanics. A food safe coating and stainless steel covers make the PX print module perfect with outstanding features. It is bolt compatible with competitive print modules.

The Universal

The industrial module for precise printing.

1.1	Print module	PX4			PX 4.3*	
	Print resolution dpi	203	300	600	203	300
	Print width up to mm	104	105,6	105,6	104	108,4
	Print speed up to mm/s	300	250	100	250	250

*4.3 preferably for thermal direct printing.

The Wide

Focused on Odette and UCC labels.

1.2	Print module	PX6	
	Print resolution dpi	203	300
	Print width up to mm	168	162,6
	Print speed up to mm/s	200	200

Label peeling direction

Print module PX „L“



left hand version

Print module PX „R“



right hand version

All PX print modules are available in right and left hand versions and different resolutions.

Technical details



- 1 Big graphic display**
White backlight for optimum readability.
- 2 Navigator pad**
With illuminated lettering for interactive menu navigation.
- 3 CF memory card**
Slot for CF memory card for storage of label formats, fonts, texts, graphics, programs or databases.
- 4 USB slot**
Additional USB slot for service keys, keyboard, scanner or USB memory.
- 5 Power switch**
Attached to the front for easier handling.
- 6 Solid metal cover**
Made of die-cast aluminum with antibacterial coating. All casings are made of stainless steel.
- 7 Ribbon rewinder and unwinder**
The three-part tightening axles enable fast and easy ribbon exchange. Narrow ribbons can be fixed in any position.
- 8 Ribbon saver**
Used for labels that are only to be partially printed. During label feed the printhead is lifted in the blank area and the ribbon is stopped.

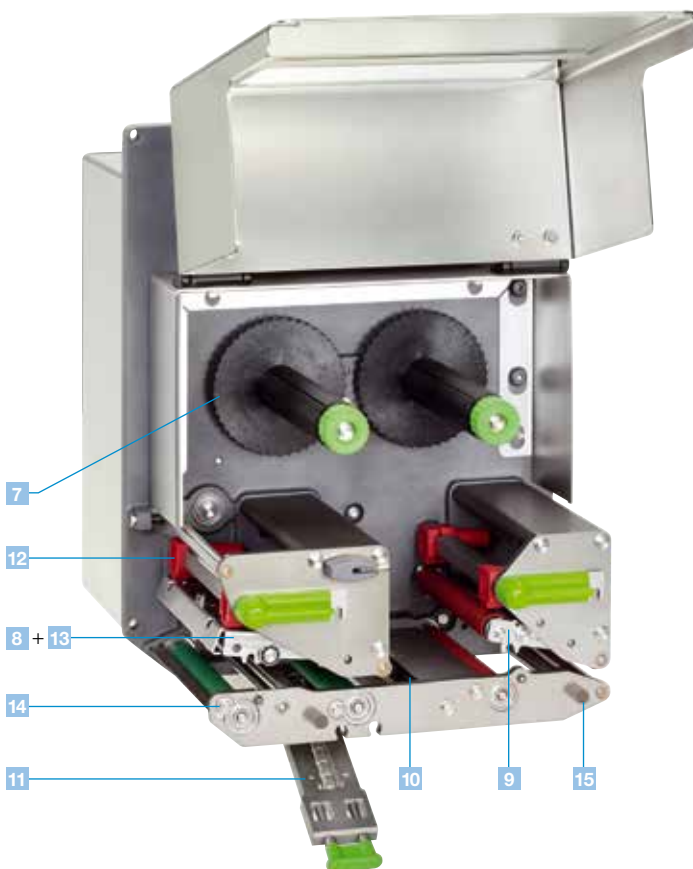

- 9 Back-feed**
Once a label has been dispensed, the next one can be fed back behind the print line to ensure it can be printed right to the edge and to prevent the liner from leaking adhesive during a longer pause. With very sensitive materials and to avoid ribbon folds, the printhead can be raised during this process.
- 10 Label sensor**
The gap or reflective sensor ensures the label is positioned precisely and identifies the end of the material – independent of gaps.
- 11 Simple material replacement**
The label material is inserted edgewise up to the end position. The printhead and pressure roller are locked with locking levers.
- 12 Adjustment of the print layout**
The pressure can be adjusted easily by moving the plungers.
- 13 Fast printhead exchange**
The printhead can be exchanged and adjusted easily using the Allen key, which is ready to hand at the machine.
- 14 Removing the print roller**
The print roller can be easily removed for cleaning or replacement.
- 15 Cover magnet**
In overhead installation, the cover is held by two magnets.

Technical data

■ Standard □ Option ○ Authorized distribution by resellers

Print module	PX4			PX4.3 ²⁾		PX6	
Printhead							
Printing method	Thermal transfer / Thermal direct						
Print resolution dpi	203	300	600	203	300	203	300
Print speed up to mm / s	300	250	100	250	250	200	200
Print width up to mm	104	105,6	105,6	104	108,4	168	162,6
Material							
Labels, continuous rolls or fan-folded	Paper, cardboard, textiles, plastics such as PET, PE, PP, PI, PVC, PU, Acrylat						
Thickness mm / weight g/m ²	0,055 - 0,35 / 60 - 160						
Label width ¹⁾ mm	10 - 116					50 - 174	
Width of carrier ¹⁾ mm	25 - 120					50 - 178	
Label height ¹⁾ min. mm without back-feed min. mm when dispensing ¹⁾ max. mm	6	6	6	6	6	12	12
	12	12	12	12	12	25	25
	5000	4000	1000	5000	4000	4000	3000
Ribbon							
Ink	Outside or inside						
Roll diameter up to mm	86						
Core diameter mm	25						
Ribbon length variable up to m	600						
Width ³⁾ up to mm	114						165
Ribbon saver	□						
Label sensor							
Gap sensor	For leading edge of the label or punching marks and end of material						
Reflective sensor from the bottom	For printing marks						
Distance to locating edge mm	4 - 60						
Electronics							
Processor high speed 32 Bit ColdFire / speed MHz	266						
RAM MB	64						
Memory IFFS MB Flash	8						
Slot for CompactFlash Type I	■						
Slot for wireless LAN card	■						
Real-time clock, printout of date and time	■						
Interfaces							
Centronics bidirectional acc. to IEEE 1284	□						
RS232 C 1,200 to 230,400 Baud / 8 Bit	■						
USB 2.0 high speed slave for PC connection	■						
Ethernet 10 / 100 Base T, LPD, RawIP printing, ftp printing, DHCP, HTTP, FTP, SMTP, SNMP, TIME, Zeroconf, mDNS, SOAP	■						
RS422, RS485 1.200 up to 230.400 Baud / 8 Bit	□						
Wireless Bridge 802.11b	□						
2x USB master for external operation panel, keyboard, scanner or service key, USB flash drive	■						
Digital I/O interface (cab other OEM version)	■						
Operating data							
Power supply	100 - 240 V ~ 50 / 60 Hz, PFC						
Energy consumption	max. 250 W						
Operating temperature / Humidity	Operation:	+ 5 - 40°C / 10 - 85% not condensing					
	Stock:	+ 0 - 60°C / 20 - 80% not condensing					
	Transport:	- 25 - 60°C / 20 - 80% not condensing					
Approvals	CE, FCC class A, CB, CCC, UL						
Operation panel							
Buttons / LED display	Pause, Feed, Cancel, Menu, Enter, 4 x Cursor						
LCD graphic display	Text 4 lines, ca. 20 characters per line						
Width x Height mm	60 x 40						
Settings							
	Digital or analog clock System settings	Print parameters 24 language settings	Interfaces Security	Time Date			
Monitoring							
Stop printing if:	End of ribbon End of label Printhead open						
On the display	Data reception WLAN field intensity Ethernet status	Used memory Temperature of printhead Access to memory card	Clock Date sheet abc Debug	Input buffer Remaining quantity of ribbon			

¹⁾ Limitations may apply to small labels, thin materials or strong adhesives. Critical materials or applications must be tested and approved.

²⁾ Preferred for thermal transfer printing.

³⁾ The ribbon should be roughly the same width as the label in order to avoid folding.

Technical data

Test routines	
System diagnosis	When switched on, incl. printhead testing
Short status, status print	Font list, device list, WLAN status, profile of label, test grid, monitor mode, PPP status
Status reports	Extensive status printout with information about setting, e.g. print length counter, runtime counter etc. Request of machine status via software command. Detailed status messages on the display, e.g. network error – no link, barcode error, etc..
Fonts	
Font types	5 Bitmap fonts incl. OCR-A, OCR-B and 3 Vector fonts Swiss 721, Swiss 721 Bold and Monospace 821 available internally, loadable TrueType fonts. Thai and Chinese (simplified Chinese) available as options.
Character sets	Windows 1250 up to 1257, DOS 437, 737, 775, 850, 852, 857, 862, 864, 866, 869, EBC DIC 500, ISO 8859-1 to -10 and -13 up to -16, WinOEM 720, UTF-8, Macintosh Roman, DEC MCS, KOI8-R. All West and East European Latin, Cyrillic, Greek, Hebrew and Arabic characters are supported. Thai and Chinese available as options.
Bitmap fonts	Size of width and height 1 – 3 mm Zoom 2-10 Orientation 0°, 90°, 180°, 270°
Vector / TrueType fonts	Size of width and height 0.9 – 128 mm Variable zoom, Orientation 360° in steps of 1°
Font formats	Bold, italic, underlined, outline, negative, vertical, depending on character fonts
Font width	Variable
Graphics	
Graphic elements	Line, arrow, box, circle, ellipse, filled and filled with fading
Grafikformate	PCX, IMG, BMP, TIF, MAC, GIF, PNG

Barcodes		
Linear barcodes	Code 39, Code 93	Interleaved 2 / 5
	Code 39 Full ASCII Code 128 A, B, C EAN 8, 13 EAN / UCC 128 EAN / UPC Appendix 2 EAN / UPC Appendix 5 FIM HIBC	Ident- u. Leitcode der Deutschen Post AG Codabar JAN 8, 13 MSI Plessey Postnet RSS 14 UPC A, E, E0
2D codes	Aztec, Codablock F, Data Matrix, PDF 417, Micro PDF 417, UPS Maxicode, QR-Code, RSS 14 truncated, limited, stacked and stacked omnidirectional, EAN-Datamatrix, GS1 Data Bar	
	All codes variable in height, module width and ratio. Orientation 0°, 90°, 180°, 270°. Optionally with check digit, printed characters and start/stop code, depending on code type.	
Software		
Programming	J-Script direct programming abc-Basic Compiler Database Connector SAP Replace method	■ ■ ■ ■
System diagnosis / administration	Printer monitoring with Intra- and Internet with web interface Network Manager	■ ■
Label software	cablabel® S3 Lite cablabel® S3 Viewer cablabel® S3 Pro	■ ■ □
Windows driver 32 / 64 bit certified for	Windows Vista Server 2008 Windows 7 Server 2008 R2 Windows 8 Server 2012 Windows 8.1 Server 2012 R2 Windows 10 Server 2016	■
Mac driver	OS X printer driver from version 10.6	■
Linux driver	CUPS-based from version 1.2	■
Stand-alone-operation		■

Interfaces















- 1 RS232C interface
- 2 USB 2.0 slave interface
- 3 Ethernet 10/100 Base T interface with TCP/IP
- 4 Two USB master interfaces for connecting an external operation panel, keyboard, scanner or service key
- 5 Slot for CompactFlash Type I memory card

- 6 Digital I/O interface
25-pin SUB D socket
Each of the 24V inputs and outputs are electrically isolated

Inputs Label feed Repeat print run Start printing Pause Label dispensed Cancel re-set with memory Cancel re-set without memory	Outputs Warning if end of ribbon Warning if end of label Paper feed ON Print start Error end of ribbon Error end of label Print data available Operating status Label in dispensing position Error printer
--	---
- 7 OEM – digital I/O interface
15-pin SUB D socket
Each of the 5V inputs and outputs are electrically isolated

Inputs Label feed Repeat print run Start printing Cancel reset without memory	Outputs Warning if end of ribbon Paper feed ON Error end of ribbon Error end of label Print data available Label in dispensing position Error printer
--	---

Accessories for all models

Extras	
2.1	 <p>External panel Connected via USB interface. Both panels provide the same functionality.</p>
2.2	 <p>Interface cover Protects the interfaces against humidity and contamination.</p>
2.3	 <p>25-pin SUB D interface connector With screw clamps for the cable connection.</p>
2.4	 <p>15-pin SUB D interface connector With screw clamps for the cable connection.</p>
2.5	 <p>Memory card CompactFlash Type I</p>
2.6	 <p>Standard keyboard USB German Version</p>
2.7	 <p>Cover magnet By these, in overhead installation the cover is held</p>
Interfaces	
3.1	 <p>Centronics interface bidirektional nach IEEE 1284</p>
3.2	 <p>Interface RS422/RS485 1.200 up to 230.400 Baud/8 Bit</p>
3.3	 <p>Label selection box – I/O box From a higher-level control, like a PLC, up to 16 different labels can be selected from the memory card. The I/O box enables via abc programming to realize easy programming of the PLC with the 4 in- and outputs.</p>
Connecting cables	
4.1	 <p>Connecting cable RS232 C 9/9 pin, length 3 m</p>
4.2	 <p>Patch cable KAT 5e, 3 m grau</p>



Device functionality and compliance with CE standards are only warranted by using the accessories provided or recommended by cab.

Software features of the print module

J	Job start
H 100	Speed (100 mm/s)
O R	Orientation rotated by 180°
S I1;0,0,68,70,100	Size label (100x68 mm, gap 2 mm)
T 10, 10,0,5,pt20;sample	Text object/font: Swiss bold, 20 pt
B 10,20,0,EAN-13,SC2,401234512345	Barcode EAN 13, size SC 2
G 8,3.5,0;R:30,9,0,3;0,3	Graphic, box 30x9 mm,
A 1	Line weight 0.3 mm
	Number of labels (in this example 1)

Direct programming with JScript

Every cab printer can be directly programmed with the JScript programming language. JScript is described in the programming manual. The label software cablabel S3 optimally supports the direct programming, but may also be generated with any text editor.

SAP® Member Silver Printer Vendor Program

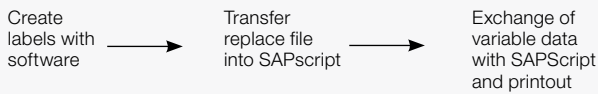

Replace files and integration in SAP R/3*)

In cooperation with SAP cab developed the so-called replace method to control cab printers quickly and easily from SAPscript using SAP R/3. Using this method the host computer only sends the JScript variable, respectively changed data to the printer. As a Silver Level partner in SAP's Printer Vendor Program, cab has access to SAP development environments for optimum printer support.

```

<ABC>
label start
input a$
if left$(a$,15)="194300301480070" then
  print "R t2;",mid$(a$,16)
endif
if left$(a$,15)="194300300580172" then
  print "R t3;",mid$(a$,16)
endif
if left$(a$,15)="194300301970073" then
  print "R t1;",mid$(a$,16)
endif
if a$0"Q0001" then
  print "A 1"
endif
goto start
  
```

abc Basic Compiler

As an integrated element of the firmware, the abc Basic Compiler enables the printer to process data via Basic programming before it is sent for print editing. That way, you replace external printer languages or integrate data from other systems, e.g. a scale or PLC.



Printer monitoring with Intra- and Internet

Using standard programs such as the web browser or ftp clients, the integrated HTTP and ftp servers enable printer monitoring and configuration, firmware updates and memory card administration. Status, warning and error messages are sent to administrators or users via e-mails or SNMP datagrams via SNMP and SMTP clients. A time server is used to synchronize time and date.

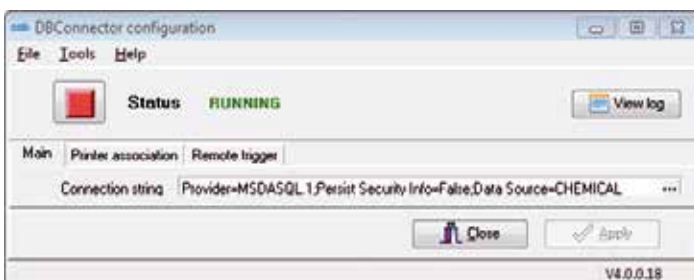

Database Connector

In stand-alone operation with additional network connection this program allows the printer to access data directly from a central ODBC or OLEDB compatible database and print it on a label. At the same time, data can be written back to the database during the printing process. Integrating the Database Connector in cablabel S3 allows to conveniently establish this database connection when designing a layout.

*) SAP and all SAP logos are trademarks or registered trademarks of SAP SE in Germany and in several other countries.

Software tools – label software

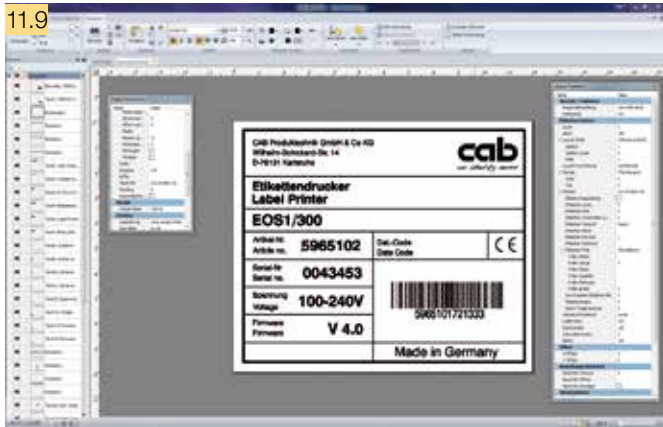

cablabel S3 is a label software offering three functions:

- **Designing**
- **Printing**
- **Monitoring**

cablabel S3 does open up the full potential of cab devices in the design of your label. An extensive instruction set is available within the intuitive user interface, e.g. different date formats, mathematic or logic functions.

In doing so, cablabel S3 brings together all cab marking systems. First of all you design the label. You do not have to decide before printing whether you like the label to be dispensed on a label printer, a print and apply system or a laser marking system.

cablabel S3 is available for the following Microsoft*) operating systems in 32 bit and 64 bit versions:

Windows Vista	Windows Server 2008
Windows 7	Windows Server 2008 R2
Windows 8	Windows Server 2012
Windows 8.1	Windows Server 2012 R2
Windows 10	Windows Server 2016

Terminal servers/Citrix are not supported.

Do you like your marking system to print independently of a host system in stand-alone operation? cablabel S3 supports again: After having designed the label, the software supplies with all necessary data stored within the printer to be used in stand-alone operation.

cablabel S3 is of modular design and can be adapted to your requirements step by step: In order to support functions like native programming with JScript, elements like JScript viewer are embedded as plugin. The designer user interface and JScript code are synchronized in real-time. Special functions like Database Connector or barcode testers can be easily integrated.

Software tools – monitoring

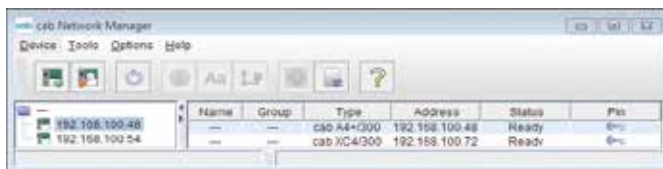

Administration Network Manager

To simultaneously control a number of printers across a network. It supports monitoring, configuration, firmware updates, memory card administration, file synchronization and PIN administration from one place.

Printer drivers

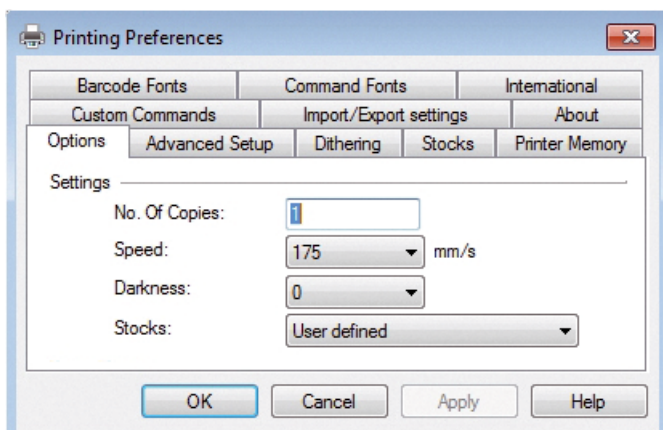

WHQL certified Windows printer drivers for

Windows Vista	Windows Server 2008
Windows 7	Windows Server 2008 R2
Windows 8	Windows Server 2012
Windows 8.1	Windows Server 2012 R2
Windows 10	Windows Server 2016

Our printer drivers are certified and signed by Microsoft. They ensure optimum stability on your Windows operating system. The drivers are included in in the scope of delivery.

*) Microsoft is a registered trademark of the Microsoft Corporation.



Stand-alone operation

Printing without PC

Stand-alone operation is the ability to print labels even if the printer is not connected to the host system.

The label layout is designed with the label software cablabel S3 or direct programming via PC.

Label formats, fonts, font-, text- and graphics data as well as data base contents are saved on the USB stick or read on the internal data memory IFFS.

Only variable data to be printed is sent to the printer via keyboard or scanner.



Easy maintenance

Printhead 203 / 300 / 600 dpi







The printhead can be exchanged and adjusted easily using the Allen key, which is ready to hand at the machine.



Removing the print roller

The print roller can be easily removed for cleaning or replacement.

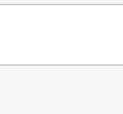
Delivery program for the PX print module

	Part no.	Hardware	dpi	
1.1		5956102.xxx	Print module PX4L / 200	
		5956103.xxx	Print module PX4L / 300	
		5956106.xxx	Print module PX4L / 600	
		5956142.xxx	Print module PX4.3L / 200	
		5956143.xxx	Print module PX4.3L / 300	
		5956112.xxx	Print module PX4R / 200	
1.2		5956113.xxx	Print module PX4R / 300	
		5956116.xxx	Print module PX4R / 600	
		5956152.xxx	Print module PX4.3R / 200	
		5956153.xxx	Print module PX4.3R / 300	
		5956235.xxx	Print module PX6L / 200	
		5956123.xxx	Print module PX6L / 300	
		5956236.xxx	Print module PX6R / 200	
		5956133.xxx	Print module PX6R / 300	
		Part no.	Hardware optionen	
		595.xxx.201	Digital I/O interface	
	595.xxx.202	Digital I/O interface Ribbon saver		
	595.xxx.203	OEM – Digital I/O interface		
	595.xxx.204	OEM – Digital I/O interface Ribbon saver		
Scope of delivery				
	DVD:	PX print module as label printer, Power cable type E+F, length 1.8 m, Connecting cables USB, length 1.8 m Operating manual de/en Operating manual de/en/fr, Configuration manual de/en/fr, Service manual de/en, Spare parts list de/en, Programming manual en, Windows printer driver 32/64 bit in 19 languages for Windows Vista Server 2008 Windows 7 Server 2008 R2 Windows 8 Server 2012 Windows 8.1 Server 2012 R2 Windows 10 Server 2016 Label software cablabel® S3 Lite and Viewer Database Connector en (without license)		
Part no.	Consumables			
	5956381.001	Printhead 4 / 203		
	5956382.001	Printhead 4 / 300		
	5956383.001	Printhead 4 / 600		
	5956385.001	Printhead 4.3 / 200		
	5956384.001	Printhead 4.3 / 300		
	5954217.001	Printhead 6 / 200		
	5954180.001	Print roller DR4		
	5954245.001	Print roller DR6		

	Part no.	Accessories	
2.1	 5954380	External operation panel	
2.2	 5965040	Interface cover	
2.3	 5917651	Interface connector 25-pin SUB D with screw clamps for cable connection	
2.4	 5917652	Interface connector 15-pin SUB D with screw clamps for cable connection	
2.5	 5561043	CompactFlash Type I memory card	
2.6	 5901626	Compact keyboard USB Cherry G84-4100	
2.7	 5972523	Cover magnet	
Part no.		Interfaces	
3.1	 5954200	Centronics interface	
3.2	 5954201	RS422 / RS485 interface	
3.3	 5948205	Label selection box – I/O box	
Part no.		Connecting cables	
4.1	 5550818	Connecting cable RS232 C 9/9 pin, length 3 m	
4.2	 5918008	Patch cable KAT 5e, 3 m gray	
Part no.		Software	
11.9		5588000	Label software cablabel® S3 Lite
		5588001	cablabel® S3 Pro 1 WS
		5588100	cablabel® S3 Pro 5 WS
		5588101	cablabel® S3 Pro 10 WS
		5588150	cablabel® S3 Pro 1 additional licence
		5588151	cablabel® S3 Pro 4 additional licences
		5588152	cablabel® S3 Pro 9 additional licences
		5588002	cablabel® S3 Print 1 WS
		5588105	cablabel® S3 Print 5 WS
		5588106	cablabel® S3 Print 10 WS
		5588155	cablabel® S3 Print 1 additional licence
		5588156	cablabel® S3 Print 4 additional licences
	5588157	cablabel® S3 Print 9 additional licences	
	In preparation	cablabel® S3 Print Server	
11.10	9008486	Programming manual english, printed copy	

All information on scopes of delivery, design and technical specifications correspond to the date of the printing. Subject to change. The data provided in the catalog do not represent any warranty or guarantee. For current data see website www.cab.de/en/px

Dimensions

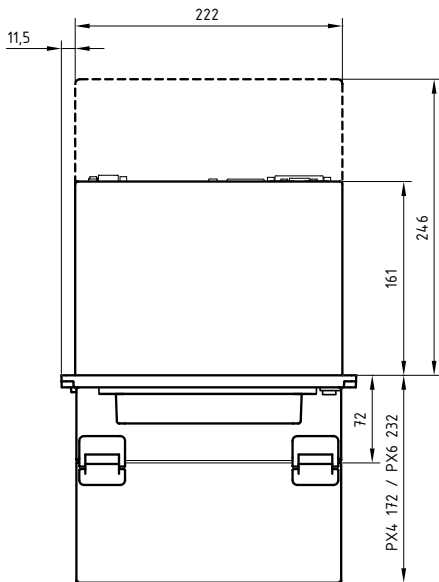
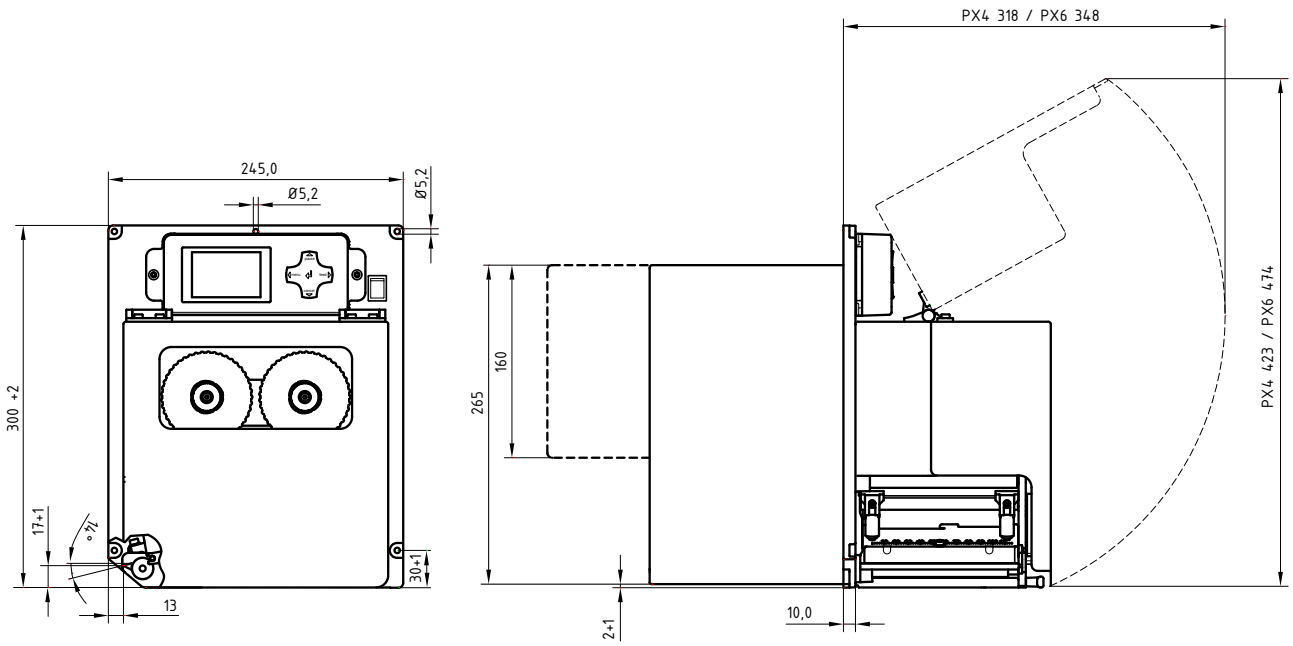

Weight of print module	PX4	PX4.3	PX6
in kg	11,5	11,5	12

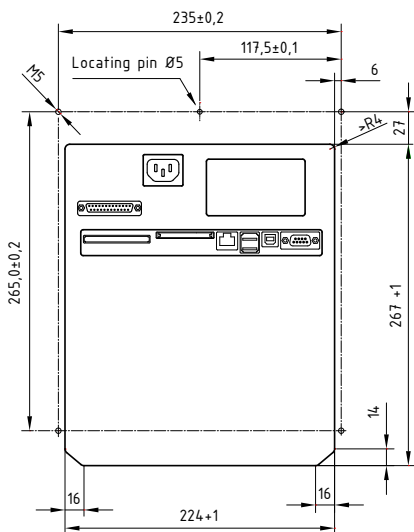

Product overview

Label printers MACH1, MACH2
in the lower price segment



Label printers MACH 4S
where little space is available



Label printers EOS1
Desktop device for label rolls
up to diameter 152 mm



Label printers EOS4
Desktop device for label rolls
up to diameter 203 mm



Label printers SQUIX 2
Industrial device for print widths
up to 57 mm



Label printers SQUIX 4
Industrial device for print widths
up to 108 mm



Label printers SQUIX 6
Industrial device for print widths
up to 168 mm



Label printers A8+
Industrial device for print widths
up to 216 mm



Label printers XD4T
for double-sided printing



Label printers XC
for two-color printing



Print and apply systems Hermes+
for automation



Print and apply systems Hermes C
for two-color printing and applying



Print modules PX
to be integrated in labeling machines



Labels
made from more than 400 materials



Ribbons
in wax, resin and resin/wax qualities



Label software cablabel S3
Design, print, control



Label dispensers HS, VS
for horizontal or vertical dispense



Labeling heads IXOR
to be integrated in labeling machines



Marking lasers FL+
with output powers 10 to 50 Watt



Laser marking systems XENO 1
for single workpieces and series

